



ISO 9001-2000 CERTIFIED

# BLOOD-DRAWING CHAIR COLLECTION

## OWNER'S OPERATING & MAINTENANCE MANUAL

2570 Blood Drawing Chair



2571 Blood Drawing Chair



2572 Padded Blood Drawing Chair



2573 Padded Blood Drawing Chair



2574 XL Padded Blood Drawing Chair



2575 XL Padded Blood Drawing Chair



2577 & 2578 Designer Blood Drawing Chair



2587-2588 Power-Lift Designer Blood Drawing Chair



**PLEASE DO NOT DISCARD THIS MANUAL! KEEP IT FOR FUTURE REFERENCE AND TRAINING**

# TABLE OF CONTENTS

PLEASE READ AND FAMILIARIZE YOURSELF WITH **ALL** INSTRUCTIONS BEFORE USING THIS PRODUCT!

If you have trouble understanding these instructions contact your dealer or Winco customer support, (800) 237-3377 before attempting to use this product; otherwise injury may occur.

**Winco assumes no responsibility for damage or injury caused by improper assembly, installation, use, or maintenance of these products.**

## Table of Contents

Winco Contact Information .....	3
Limited Warranty.....	3
Important Safety Precautions.....	4-5

### **Assembly:**

Tools Needed - Weight Capacity - Cleaning Information.....	6
Seat Installation (Models 2570-2575, 2587-2588) .....	7
Arm & Glide Foot Installation (All Models).....	8
Cabinet Assembly/Installation (Models 2570, 2572, and 2574) .....	9
Seat Height Set-up & Adjustment Instructions (Models 2577 & 2578).....	10
Seat Height Adjustment Instructions (Models 2587-2588).....	10
Optional Pivot Arm Configuration (PR & P2 options) .....	11

### **Chair Guide:**

Parts Guide & List for 2570-2571 .....	12
Parts Guide & List for 2572-2574.....	13
Parts Guide & List for 2575, 2577-2578 .....	14
Parts Guide & List for 2587-2588.....	15

# WINCO CONTACT INFORMATION & WARRANTY



ISO 9001-2000 CERTIFIED

5516 Southwest 1st Lane

Ocala, FL 34474

1-800-237-3377 / 352-854-2929 / Fax: 352-854-9544

e-mail: [customerservice@wincomfg.com](mailto:customerservice@wincomfg.com)

Visit us on the web: [www.wincomfg.com](http://www.wincomfg.com)

## Limited Warranty

### TERMS

Winco, Inc. warrants this product to be free of manufacturer's defects in material and workmanship, provided that the product is used according to normal operating conditions and proper maintenance intended by manufacturer. This warranty is available only to the original retail purchaser, is non-transferable and commences on the date of retail sale; proof of purchase required.

**LIMITED ONE YEAR COMPLETE PRODUCT WARRANTY:** Winco, Inc. warrants the complete product for one (1) year. At Winco Inc. sole discretion, it may repair or replace any components freight free that are found to be defective during the first year. Winco, Inc. shall not be liable for any labor, or any other costs incurred as a result of or in conjunction with a warranty claim.

**LIMITED THREE YEAR WARRANTY:** Winco, Inc. warrants the recliner mechanisms, electrical components, vinyl [from cracking or delaminating] pressurized gas springs, when new, for a period of three (3) years. At Winco, Inc. sole discretion, it may repair or replace components found to be defective. Winco, Inc. shall not be liable for any labor, shipping or any other costs incurred as a result of or in conjunction with a warranty claim.

**LIMITED LIFETIME CHAIR FRAME WARRANTY:** Winco, Inc. warrants the steel chair frame, when new, for the lifetime of the original purchaser. This limited warranty does not apply to paint/finish or any components attached to the frame such as; upholstery, foam, casters, mechanisms or related parts that are covered under above warranties. Winco, Inc. shall not be liable for any labor, shipping or any other costs incurred as a result of or in conjunction with a warranty claim.

The purchaser's exclusive remedy under this warranty shall be limited to such repair or replacement of defective components at Winco, Inc. sole discretion. For warranty service, contact the dealer that the product was originally purchased from or Winco, Inc. directly.

### EXCLUSIONS

There are no other warranties, conditions, representations or guarantees, express or implied, made or intended by Winco, Inc., and all other warranties, conditions, representations or guarantees including any warranties, conditions, representations or guarantees under any Sale of Good Act or Like legislation or statute is hereby expressly excluded. Any and all other implied warranties shall not extend beyond the duration of the express warranty. Liability for incidental or consequential damages is excluded to the extent permitted by law. Some states do not allow the exclusion or limitation so the above limitation or exclusion may not apply to you. This warranty gives you specific legal rights. In addition you may also have other rights, which vary from state to state.

### GENERAL PROVISIONS

No warranty herein contained or set out shall apply when damage or repair is caused by any of the following:

1. Damage in transit.
2. Accident, alteration, abuse or misuse of product ie. exceeding weight capacities, applying inordinate pressure to footrest/leg rest, use in Mental Health facilities or like institutions.
3. Fire, water damage, theft, war, riot, hostility, acts of God.

*Examples contained in this list are not to be construed as all-inclusive.*

# IMPORTANT - PLEASE READ



## ***FOR PRODUCTS WITH POWERED OPTIONS***

***Read all instructions before using this product.***

### **IMPORTANT SAFETY INSTRUCTIONS - SAVE THESE INSTRUCTIONS**

***To reduce the risk of electric shock when using an electrical appliance, basic precautions should always be followed, including the following:***

DANGER - Always unplug this product from the electrical outlet before cleaning, maintenance or when putting on or taking off parts.

#### WARNING:

1. Unplug this product from the electrical outlet if this product is not to be used for extended periods of time.
2. Supervision should be provided when this product is used by, on, or near children, invalids, or disabled persons.
3. Use this product only for its intended use as described in this manual. Do not use attachments not recommended by the manufacturer.
4. Never operate this product if it has a damaged cord or plug, if it is not working properly, if it has been dropped or damaged, or dropped into water. Return the product to an authorized Winco service center.
5. DO NOT carry or pull this product by power supply cord or use the cord as a handle.
6. Keep the cord away from heated surfaces.
7. Do not use outdoors, operate in a wet condition or environment
8. To disconnect, remove plug from outlet. Do not "yank" cord.
9. Clean foot controls with a damp cloth only – Warranty will be VOID if liquid is introduced into control mechanism.
10. Use only a certified extension cord that is rated at 15 amperes; extension cords rated for less amperage may over heat. Care should be taken to arrange the cord so that the cord cannot be pulled or tripped over.
11. DO NOT run other equipment over cord.
12. This chair comes with a grounded three blade plug, if the plug does not fit into the outlet; contact a certified electrician to install the proper outlet. DO NOT MODIFY THE PLUG IN ANY WAY.

WARNING: Connect this product to a properly grounded outlet only. (see grounding instructions, pg.5)

# IMPORTANT - PLEASE READ

## **GROUNDING INSTRUCTIONS:**

This product must be grounded. If it should malfunction or breakdown, grounding provides a path of least resistance for electric current to reduce the risk of electric shock. This product is equipped with a cord having an equipment-grounding conductor and a grounding plug. The plug must be plugged into an appropriate outlet that is properly installed and grounded in accordance with all local codes and ordinances.

**DANGER** - Improper connection of the equipment-grounding conductor can result in a risk of electric shock. Check with a qualified electrician or serviceman if you are in doubt as to whether the product is properly grounded. Do not modify the plug provided with the product - if it will not fit the outlet, have a proper outlet installed by a qualified electrician.

This product is for use on a nominal 120-volt circuit and has a grounding plug. Make sure that the product is connected to an outlet having the same configuration as the plug. No adapter should be used with this product.

For an added level of safety; Winco recommends the use of a 120 volt GFCI (ground fault circuit interruptor) outlet.



1. READ AND FOLLOW ALL DIRECTIONS.
2. Chair should ALWAYS be positioned on level surface.
2. Children MUST be supervised at all times when near chair.
3. DO NOT stand on chair.
4. DO NOT use movable arm as a restraint device
4. DO NOT put hands, feet or clothing into any openings when changing positions on chair  
Attendant MUST confirm that users arms, legs, hands and feet are safe while changing chair positions or SERIOUS INJURY MAY RESULT.
4. STAY CLEAR of moving parts.
5. DO NOT use chair for transporting in or with ANY type of vehicle or trailer. Winco chairs have not been tested or approved for use by an occupant in any type of vehicle or trailer.
6. NEVER use the chair arms or backrest as a seat; SERIOUS INJURY or damage may occur.
7. Failure to completely tighten the seat mounting screws COULD RESULT IN INJURY.
8. Periodically check the tightness of all nuts, bolts and screws.
8. Immediately REMOVE FROM SERVICE; Any chair with broken parts, torn upholstery, or other mechanical or visible damage.
9. USE ONLY WINCO AUTHORIZED REPLACEMENT PARTS.
10. NEVER EXCEED the recommended weight capacity - see pages 6.
11. SAVE THESE INSTRUCTIONS for future reference and training.

## Tools Needed

### **Models 2570–2575:**

- Multiple size wrench included (or your own 5/16, 3/8" & 7/16" or adjustable wrenches)
- Phillips-head screwdriver
- Scissors or box cutter
- Powered tools not recommended

### **Models 2577-2578 & 2587-2588:**

- Multiple size wrench included (or your own 7/16" or adjustable wrench)
- 3/16" Hex "Allen" wrench included
- "Phillips-head" screwdriver – for checking tightness of all screws after shipping
- Scissors or box cutter
- Powered tools not recommended.

### **Before you begin:**

- Check your product for any shipping damage, remove all hardware and packing material that was secured for shipping.
- You may have to cut down the cardboard container with a box cutter to access the product. Use CAUTION to avoid cutting your skin or damaging the product.
- If you have questions about your assembly or if the product is damaged in ANY way, please contact Winco Customer Support at 1-800-237-3377.

## Weight Capacities

### **Models 2570–2573, 2577-2578, & 2587-2588:**

- MAXIMUM Weight Capacity= 300 lbs. (136kg.)

### **Models 2574-2575:**

- MAXIMUM Weight Capacity= 450 lbs. (284 kg.)

## General Care & Cleaning

Remove hair & body oils; Your recliner should be cleaned with mild soap & water solution and a damp cloth on a regular basis (especially where skin & hair make contact with upholstery). Avoid harsh detergents or chemicals that could damage the upholstery or finish of your recliner. If the recliner is disinfected, the chair MUST be wiped off with ONLY clean water on a damp cloth.

Note: Disinfectants alone, will not provide adequate "grease or oil cutting" properties to remove hair & skin oils. Over time, the appearance and feel of your upholstery may diminish if not cleaned properly.

Please refer to the **PERMABLOK** instruction tag that is attached to your Care Cliner for complete care and cleaning instructions.  
*Retain information on tag for future use*

FOR FURTHER CLEANING INFORMATION VISIT:

<http://www.wincomfg.com/permablok-info-and-cleaning-instructions>



# Seat Installation 2570-2575, 2587-2588

## WARNING

Failure to completely tighten the seat mounting screws  
COULD RESULT IN SERIOUS INJURY.

### **Models 2570 and 2571 (FIG. 1)**

1. Position **Chair Frame** in upright position. Check tightness of all installed screws, bolts and nuts in case they loosened during shipping.
2. Align the mounting holes on the plastic **Seat** with the **Seat Support** holes. Hole spacing of Seat and Seat Supports will be narrower toward front of chair. Seat can only be installed facing one direction. **FIG 1**
3. Using the included wrench (or your own 5/16" tool), install the (4) 705300 **Seat Screws** through the holes of Chair Frame, and into the four (4) holes on bottom of the plastic Seat. Make sure screws are completely tightened. **FIG 1**

**NOTE:** These "special" screws **MUST BE USED** for maximum grip in this seating application. They can be slightly difficult to "get started" in the holes on the plastic Seat.

**TIP:** Use even pressure and, if available, a "5/16" nut-driver" (screw-driver-type handle with a 5/16" socket on end) however, this task can be accomplished with the included wrench.

### **Models 2572, 2573, 2587, 2588 (FIG. 2)**

1. Position **Chair Frame** in upright position. Check tightness of all installed screws, bolts and nuts in case they loosened during shipping.
2. Align the screws on bottom of the **Seat Assembly**, with the **Seat Support** holes. (Hole spacing of Seat Supports will be narrower toward front of Chair). **Seat** can only be properly installed facing one direction. Be sure that all (4) Seat Screws go completely through the Seat Support straps on chair frame.
3. Install (4) **lock nuts** to the screws on the **Seat Assembly** and completely tighten with 7/16" wrench.

### **Models 2574 and 2575 (FIG. 3)**

1. Position **Chair Frame** in upright position. Check tightness of all installed screws, bolts and nuts in case they loosened during shipping.
2. Align the screws on bottom of the **Seat Assembly**, with the **Seat Support** holes. **FIG 3**

**NOTE: Seat Supports** are angled to give the seat a very slight recline angle. The **FRONT** of seat should be positioned toward the **HIGHER** end of the strap. **FIG 3**

Be sure that all (4) Seat Screws go completely through the Seat Support straps on chair frame.

3. Install (4) **lock nuts** to the screws on the **Seat Assembly** and completely tighten with 7/16" wrench.

FIG. 1

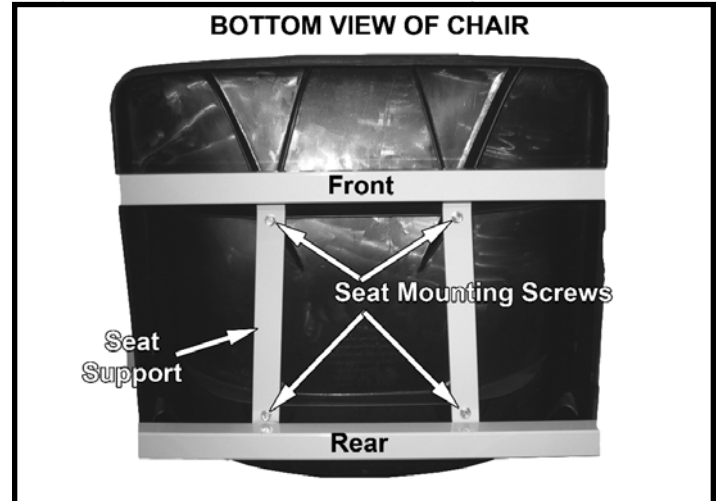

FIG. 2

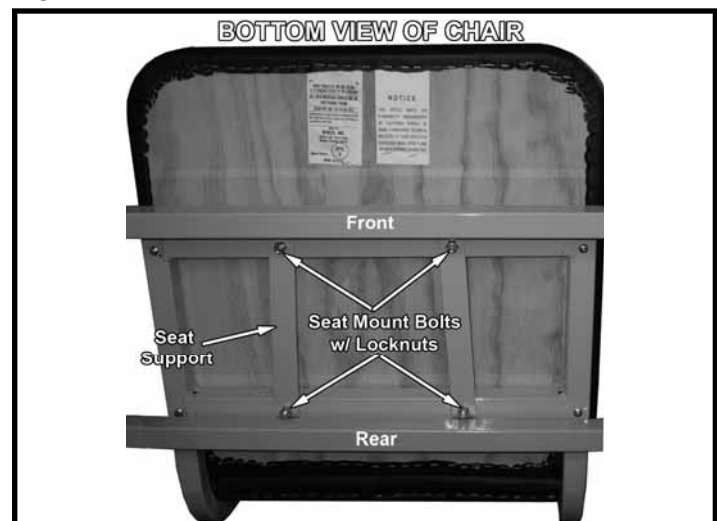
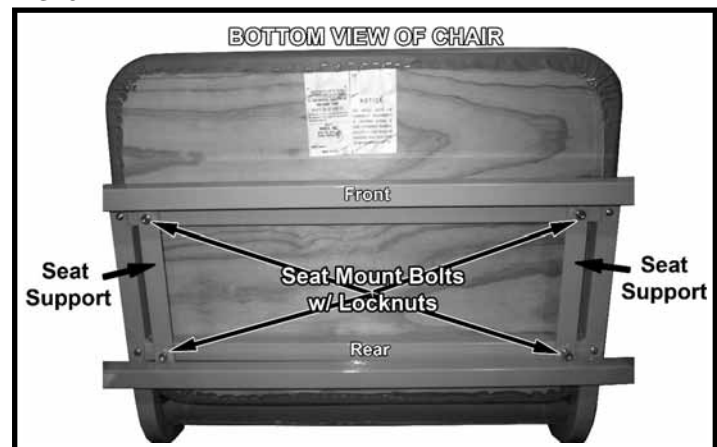
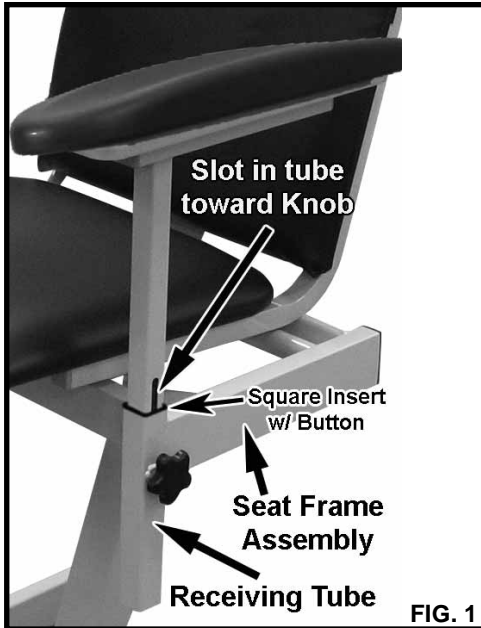

FIG. 3



# Arm Installation - All models



1. If the **Arm Assembly** has not yet been installed, insert it into the **Receiving Tube** on **Seat Frame Assembly**. (This applies to any style arm assembly)

•ALWAYS make sure that the slot in the Arm Assembly faces the Knob installed on the receiving tube. (FIG. 1)

2. Then adjust the arm to the desired height and tighten the knob. Screw the Knob into the Slot. This will “capture” the arm and keep it from being able to be pulled out of the frame accidentally.

**DO NOT OVERTIGHTEN** - The Knob will NOT need to be extremely tight to effectively hold arms in position.

# Glide Foot Installation - All models

## Glide Foot Installation

1. Place chair on side and install **(4) Glide Feet** in threaded holes on the bottom of the **Chair Frame** (FIG. 6 & 7). Lift & position the chair to the upright position, with Glide Feet on a level floor.
2. If the Chair Frame does not sit level on the floor, loosen one or two of the Glide Feet individually and adjust until the Chair Frame is level.

FIG 6 & 7  
2570-2571-2572  
2573-2574-2575

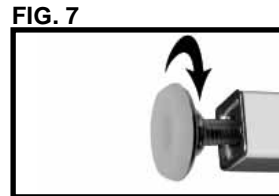
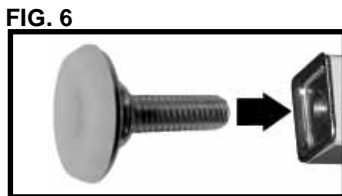

FIG 6a & 7a  
2577-2578

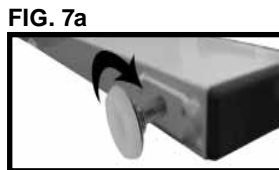
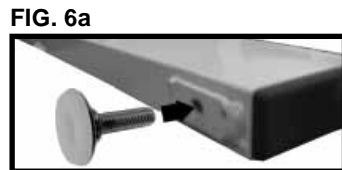
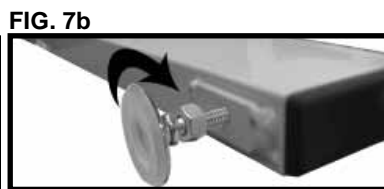

FIG 6b & 7b  
2587-2588





# Cabinet Assembly Models 2570, 2572, & 2574

1. Remove the drawer from the cabinet.
2. Attach the **Welded Cabinet Support** to bottom of Cabinet by installing **(4) 2" screws** through (4) holes in the Welded Cabinet Support. Install **washers and locknuts** on the screws inside the cabinet. **(FIG. 1)**.
3. Use the supplied wrench to hold nuts inside of cabinet & tighten screws with a Phillips scredriver.
4. Cabinet installs on **LEFT** side of chair: Use "Arm Assembly" Instructions (from previous page) to install the Cabinet Support & Cabinet to chair frame. See **(FIG. 2)** below and "Arm Installation" section on previous page.
5. Reinstall Drawer.
6. Adjust the Cabinet to desired height and tighten Knob.
7. CABINET INSTALLATION COMPLETE. **(FIG. 3)**.

**BE SURE to tighten the black knob to secure the cabinet - even if no height adjustment is made. This will secure cabinet for use.**

**Special note for chairs with "PR or P2" option:**

*If your chair was ordered with a "PR" (Pivot Arm option) then you are finished with the Cabinet install. Otherwise proceed to "PR & P2" Installation Instructions on Page 12.*

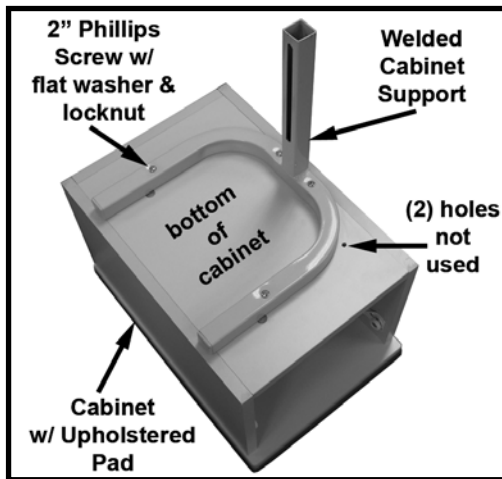

FIG. 1



FIG. 2



FIG. 3

# Models 2577 & 2578 Seat Height Set-up and/or Adjustment

The seat height of your 577-578 Designer Blood Drawing Chair can be adjusted during setup.

**CAUTION:** The **Seat Assembly** is VERY HEAVY. To adjust the height; the chair must be supported by someone that can LIFT OVER 50 LBS.

- 1. Use two people;** Use the included 3/16" Hex (Allen) wrench and the included "multi-size" wrench to remove the **nut, lockwasher & shoulder bolt** from the square post on the **Base Assembly**.
2. Align the **Seat Bracket** over **Seat Post**.
3. **IMPORTANT:** Have your helper grasp the seat by the metal seat frame to hold the **Seat Assembly** steady to prevent it from dropping;
4. Slowly lower the Seat Bracket down onto the Seat Post until the hole in the Seat Bracket is aligned with a hole on the post for the desired seat height. Re-install the shoulder bolt and locknut into one of the aligned sets of holes to obtain desired seat height. **TIGHTEN THE NUT & LOCKWASHER ON SHOULDER BOLT**

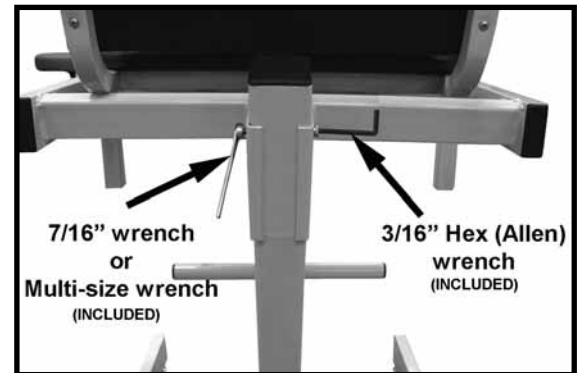
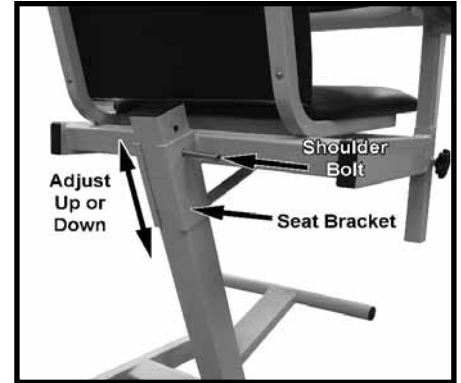
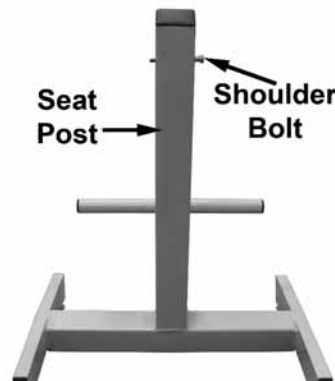

WARNING

**CHAIR MUST NOT BE USED WITHOUT SHOULDER BOLT, LOCKWASHER AND NUT COMPLETELY TIGHTENED – INJURY COULD RESULT –**

# Models 2587 & 2588 Seat Height Adjustment Instructions

**SEAT HEIGHT ADJUSTMENT:** Follow ALL safety instructions outlined in this manual.

1. Plug power cord into a properly grounded wall outlet. (SEE PG. 5)
2. Press foot down on foot control arrows to raise or lower chair to desired height.  
Chair will stay at the adjusted height when foot control is released.

# “PR” & “P2” - Optional Pivot Arm (see models listed below)

**\*\*If ordered with “L” shaped arm follow arm assembly instructions on page 8\*\***

## Models 2570-2571-2572-2573-2574-2575 PR and 2571-2573-2575 P2

Your Pivot Arm assembly may be configured in one of two (2) directions:

- Pivot point located near the back of chair – This will provide arm support that is straight or at a slight angle to the side of the patient (standard position).
- Pivot point located near front of chair – This will provide arm support across the front of the patient’s body.

1. If you wish to change the standard setup of the **Pivot Arm (FIG. 1)** so that the pivot point is toward the front of the chair; Proceed to the next step – IF NOT – skip this step.  
–If ordered Q Option, you can choose which Pivot Arm(s), if any, you wish to alter.



This change can be made before or after **Arm Assembly** is installed on chair.

2. Use a Phillips or #2 square bit screwdriver to remove the (4) **wood screws** on underside of arm assembly that hold the **Pivot Arm assembly** onto the steel **Arm Support**.

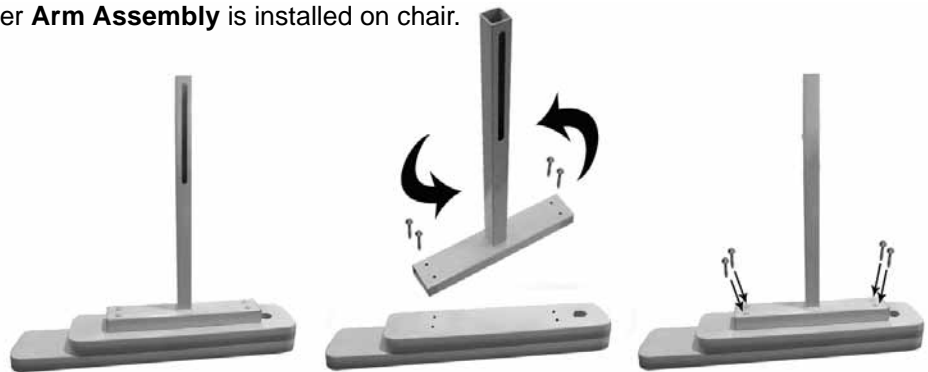

FIG. 1

FIG. 2

FIG. 3

3. After (4) **wood screws** are removed; Rotate **Pivot Arm assembly** 180 degrees (**FIG. 2**); Re-install (4) **wood screws** to secure arm in the new position (**FIG. 3**).

## Models 2577, 2578, 2587, 2588 PR & P2

1. If you wish to change the standard setup of the **Pivot Arm** so that the pivot point is toward the front of the chair; Proceed to the next step – IF NOT – skip this step.  
–If ordered P2 Option, you can choose which Pivot Arm(s), if any, you wish to alter.

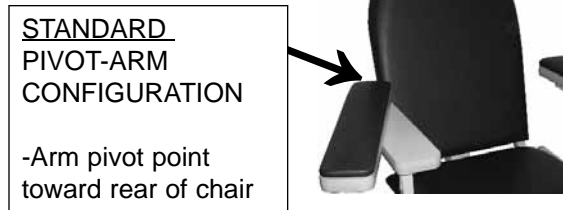

This change can be made before or after Arm Assembly is installed on chair.

2. Use a Phillips or #2 square bit screwdriver to remove the (4) **wood screws** on underside of arm assembly that hold the **Pivot Arm assembly** onto the steel **Arm Support** (**FIG. 4**).



3. After (4) **wood screws** are removed; Rotate **Pivot Arm assembly** 180 degrees (**FIG. 5**); Re-install (4) **wood screws** to secure arm in the new position.

4. If necessary, follow “Arm Installation Instructions”.

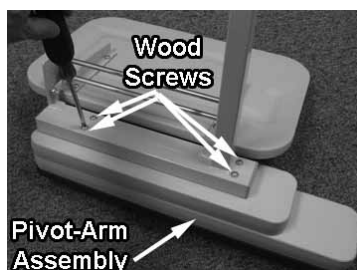

FIG. 4

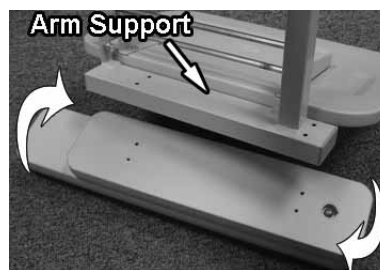

FIG. 5

# Parts Guide & List

## COMMON PARTS - for all chairs

Flip-Up Urethane Arm Rest, black (standard right armrest for all Blood Drawing Chairs) .....	708010
Small Urethane Arm Rest, black (standard left armrest for all Blood Drawing Chairs) .....	708020
Square Insert with button-Plastic (inside of receiving tube behind Star Knobs) .....	701035
Glide Foot, non-swivel .....	500350
Glide Insert, Metal (used on models 570 thru 575).....	501060
Knob, Arm/Cabinet Height Adjust ("Star shape" black w/threaded stud, for Arm or Cabinet height adjustment).....	501215
Screws, (to mount Flip-Up Urethane Arm Rest to Arm Support).....	566557
Screws, (to mount Small Urethane Arm Rest to Arm Column or Cabinet Top).....	566407
<b>**ALL Upholstered Parts**</b> (seat, back, arm pads, cabinet pad, etc...) .....	<b>Call for Special Part Numbers</b>

### 2570

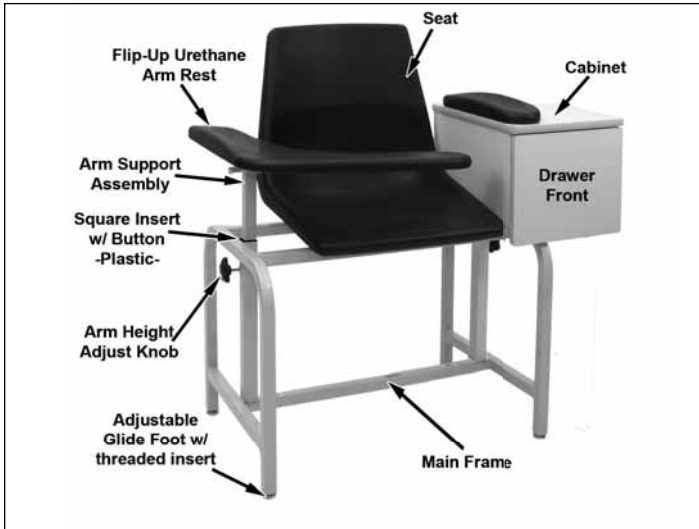

Main Frame .....	226101
Arm Support Assembly .....	226270
Welded Cabinet Support Assm.....	226340
Cabinet w/drawer & glide hardware assm.....	267405
Hex Head Screws, for Seat.....	501700
Lock Nuts, (for cabinet to support assm) .....	566203
Washers, (for cabinet to support assm) .....	566302
Screws, (for cabinet to support assm) .....	566516
Seat (black plastic) .....	705300
Adjustable Glide Foot.....	500350

\*With Pivot-Swing Arm Option:

\*Arm Assm. Wood Set (on right instead of 708010).....267300

\*Welded Arm Column (on right, instead of 226270).....226220

### 2571

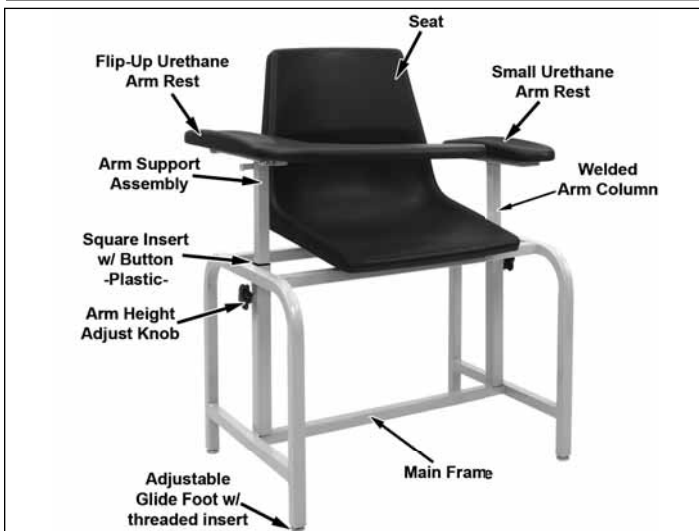

Main Frame .....	226101
Arm Support Assembly .....	226270
Welded Arm Column (for Small Arm, Left) .....	226255
Hex Head Screws, for Seat.....	501700
Seat (black plastic) .....	705300
Adjustable Glide Foot.....	500350

\*With Pivot-Swing Arm Option:

\*Arm Assm. Wood Set (RIGHT, instead of 708010).....267300

\*Welded Arm Column (RIGHT, instead of 226270).....226220

\*Arm Rest, (LEFT, small wood arm instead of 708020).....267301

# Parts Guide & List

**\*\*ALL Upholstered Parts\*\***(seat, back, arm pads, cabinet pad, etc...) ..... **Call for Special Part Numbers**

## 2572

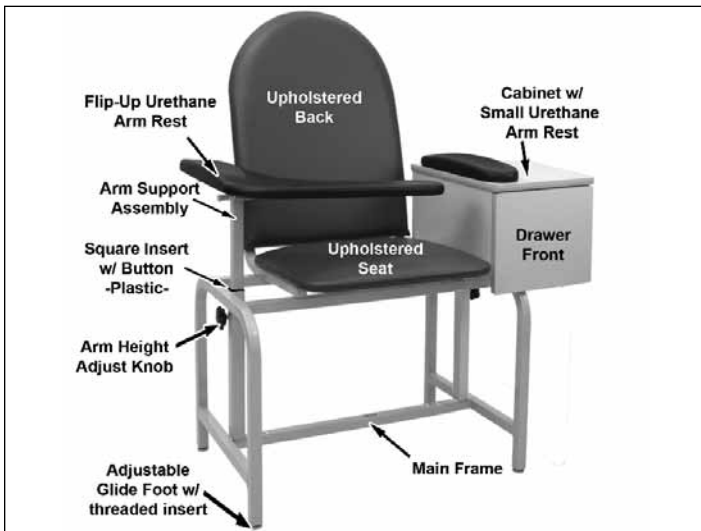

Main Frame .....	226101
Arm Support Assembly .....	226270
Seat & Back Frame .....	226300
Welded Cabinet Support Assm.....	226340
Cabinet w/drawer & glide hardware assm.....	267405
Lock Nuts, (for seat screws) .....	566204
Lock Nuts, (for cabinet to support assm) .....	566203
Washers, (for cabinet to support assm) .....	566302
Screws, (for cabinet to support assm) .....	566516
Adjustable Glide Foot.....	500350

\*With Pivot-Swing Arm Option:

*\*Upholstered Arm or Cabinet Pads. ....(call for upholstered part #'s)*

*\*Welded Arm Column (Left or Right).....226220*

## 2573

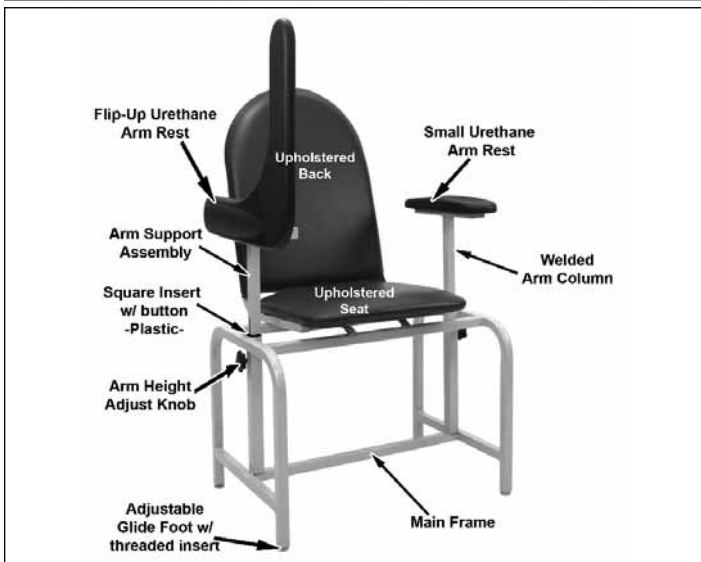

Main Frame .....	226101
Arm Support Assembly .....	226270
Welded Arm Column (for Small Arm, Left) .....	226255
Seat & Back Frame .....	226300
Lock Nuts, (for seat screws) .....	566204
Adjustable Glide Foot.....	500350

\*With Pivot-Swing Arm Option:

*\*Upholstered Arms (Left or Right). ....(call for upholstered part #'s)*

*\*Welded Arm Column (on right, instead of 226270).....226220*

## 2574

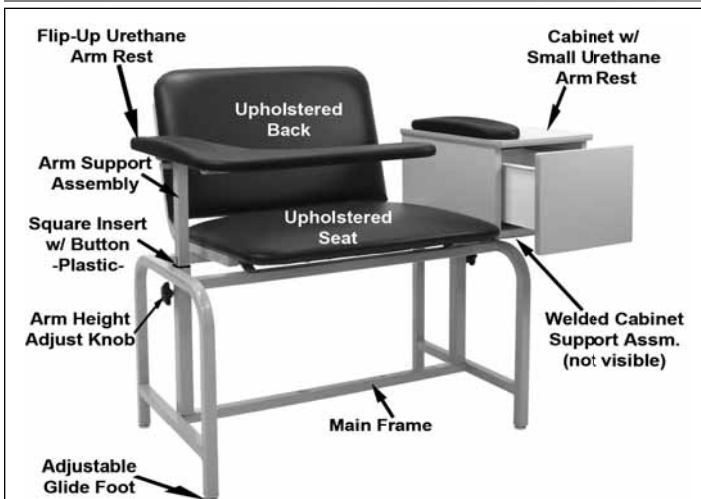

Main Frame .....	226102
Arm Support Assembly.....	226270
Lock Nuts, (for seat screws).....	566204
Welded Cabinet Support Assm.....	226340
Cabinet w/drawer & glide hardware assm.....	267405
Lock Nuts, (for cabinet to support assm) .....	566203
Washers, (for cabinet to support assm) .....	566302
Screws, (for cabinet to support assm) .....	566516
Adjustable Glide Foot.....	500350

\*With Pivot-Swing Arm Option:

*\*Upholstered Arm or Cabinet Pads. ....(call for upholstered part #'s)*

*\*Welded Arm Column (on right, instead of 226270).....226360*

# Parts Guide & List

2575

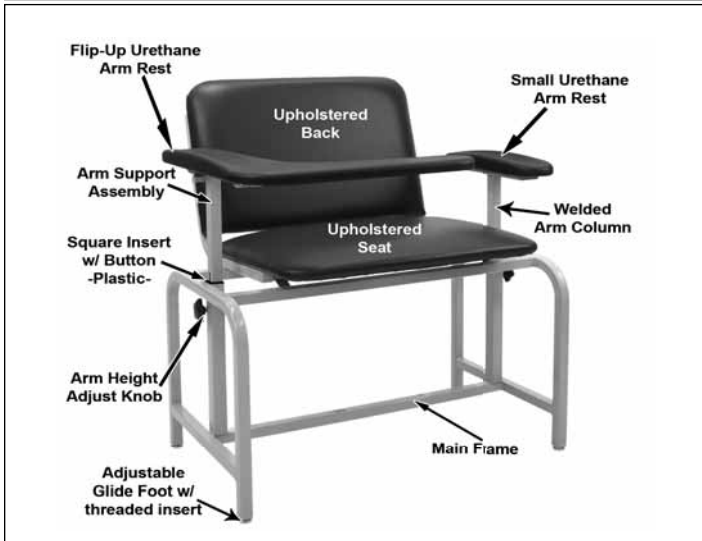

Main Frame .....	226102
Arm Support Assembly .....	226270
Welded Arm Column (for Small Arm, Left) .....	226255
Seat & Back Frame .....	226320
Lock Nuts, (for seat screws) .....	566204
Adjustable Glide Foot.....	500350

\*With Pivot-Swing Arm Option:

\*Upholstered Arms. ....(call for upholstered part #'s)

\*Welded Arm Column (on right, instead of 226270).....226360

2577 - 2578



**RIGHT SIDE, Flip-Up Urethane Arm Parts:**

Arm Support Assembly, offset (no ST brkts).....226290  
(FOR STANDARD STYLE CHAIRS **WITHOUT** A SIDE TABLE)

Arm Support Assembly, offset (ST brkts)..... 226280

Side Table w/ Cover Assm Kit (RIGHT side ONLY) ..... 261650  
(FOR STANDARD STYLE CHAIRS **WITH** A SIDE TABLE)

**LEFT SIDE, Small Urethane Arm Parts:**

Welded OFFSET Arm Column Assm, (for Sm Ureth Arm) .... 226260  
(Note: Side Table on Left side is not an available option)

**Base Parts:**

Base Weldment .....

Seat/Arm Rest Mount.....

Adjustable Glide Foot.....

Lock Nuts, (for seat screws) .....

Gray Fiberglass Shell Seat (**2577 ONLY**) .....

Seat & Back Frame (**2578 ONLY**) .....

\*With Pivot-Swing Arm Option:

RIGHT SIDE PARTS:

\*Arm Assm. Wood Set (instead of 708010).....267300

\*Welded Pivot-Arm Support, offset (NO side table brkts).....226240

\*Welded Pivot-Arm Support, offset (WITH side table brkts) ...226245

\* 2578 Upholstered Arms. ....(call for upholstered part #'s)

LEFT SIDE PARTS:

\*Arm Rest, (small wood arm instead of 708020).....267301

\*Welded Pivot-Arm Support w/Slot offset .....

\* 2578 Upholstered Arms.....(call for upholstered part #'s)

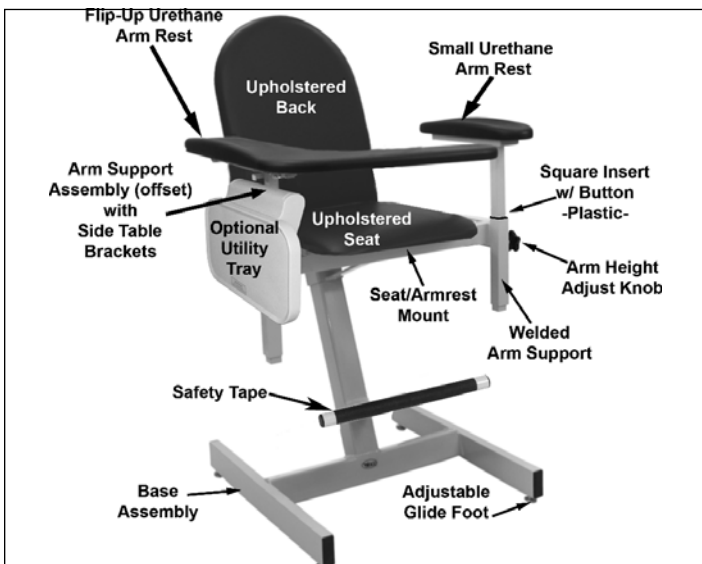

# Parts Guide & List

2587 - 2588

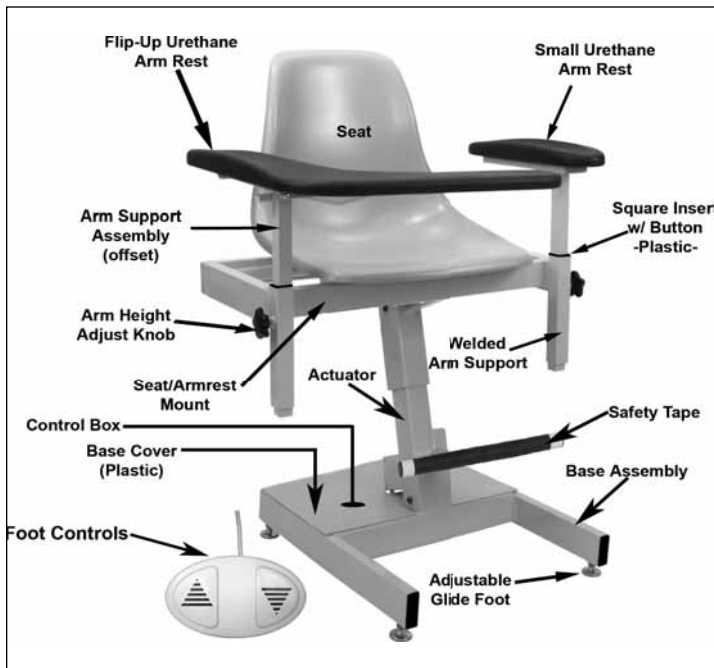

## RIGHT SIDE, Flip-Up Urethane Arm Parts:

- Arm Support Assembly, offset (no ST brkts)..... 226290  
*(FOR STANDARD STYLE CHAIRS WITHOUT A SIDE TABLE)*
- Arm Support Assembly, offset (ST brkts)..... 226280
- Side Table w/ Cover Assm Kit (RIGHT side ONLY)..... 261650  
*(FOR STANDARD STYLE CHAIRS WITH A SIDE TABLE)*

## LEFT SIDE, Small Urethane Arm Parts:

- Welded OFFSET Arm Column Assm, (for Sm Ureth Arm) ... 226260  
*(Note: Side Table on Left side is not an available option)*

## Base Parts:

- Base Weldment..... 226500
- Seat/Arm Rest Mount..... 226510
- Lock Nuts, (for seat screws) ..... 566204
- Actuator.....490100
- Control Box.....490110
- Foot Controls.....490120
- Base Cover (Plastic).....265871
- Gray Fiberglass Shell Seat **(587 ONLY)**..... 705320
- Seat & Back Frame **(588 ONLY)**..... 226440
- Adjustable Glide Foot.....500360

## \*With Pivot-Swing Arm Option:

### RIGHT SIDE PARTS:

- \*Arm Assm. Wood Set (instead of 708010).....267300
- \*Welded Pivot-Arm Support, offset (NO side table brkts).....226240
- \*Welded Pivot-Arm Support, offset (WITH side table brkts) ...226245
- \*2588 Upholstered Arms. ....(call for upholstered part #'s)

### LEFT SIDE PARTS:

- \*Arm Rest, (small wood arm instead of 708020).....267301
- \*Welded Pivot-Arm Support w/Slot offset.....226225
- \*2588 Upholstered Arms .....(call for upholstered part #'s)





ISO 9001-2000 CERTIFIED

5516 Southwest 1st Lane

Ocala, FL 34474

1-800-237-3377 / 352-854-2929 / Fax: 352-854-9544

e-mail: *customerservice@wincomfg.com*

Visit us on the web: *www.wincomfg.com*