

Respiratory ventilation products

Critical care

United States catalog



Table of contents

AVEA® ventilator products	1–6
VELA® ventilator products.....	7–11
EnVe® ventilator products	12–17
Bird® Blender products	18–21
3100A and 3100B High-Frequency Oscillatory Ventilator (HFOV) products.....	22–27
Infant Flow® nCPAP products	28–33
Index.....	34

AVEA® ventilator products

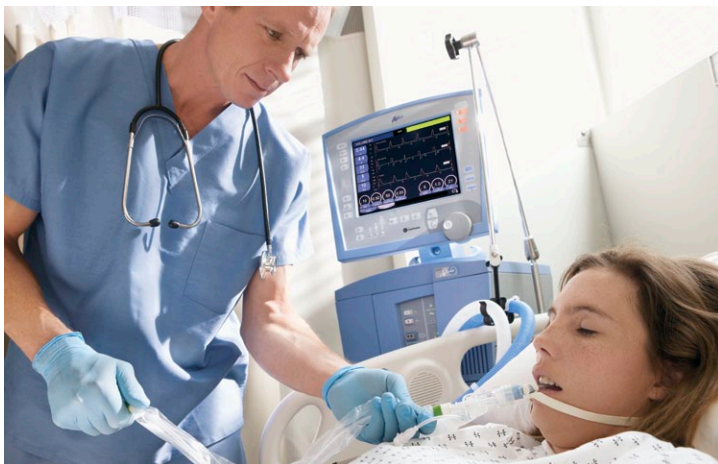

AVEA accessories



16465
AVEA neonatal hotwire flow sensor
Reusable, each



50000-40035
AVEA water trap for expiratory system
Reusable, each



33985
AVEA water trap bottle for expiratory system
Reusable, each



51000-40640
AVEA removable exhalation cartridge
Reusable, each



33987
AVEA bacterial filter
Reusable, each



22095
AVEA water trap adapter replacement
Reusable, each



51000-02736
Legacy "Bear" circuit support hanger
Each



69300A Circuit support arm with side rail mount bracket (PN 09526)
69300 Circuit support arm without side rail mount bracket (PN 09526)



09526
Side rail mount bracket



34403
Circuit support arm (PN 69300) circuit holder
Pack of 3



15619
Nurse call cable open



15620
Nurse call cable closed



33915
AVEA filter, guard assembly cooling fan
Each



71670
AVEA fan filter
Pack of 5



68289
Sensor, oxygen with connector

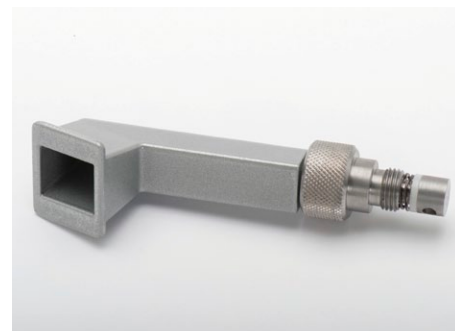

11938
Aeroneb nebulizer stand mounting kit
Rail mount bracket (PN 09526) required



Cat. no.	Description
51000-40897	Fitting, assembly, air inlet, DISS
51000-40888	Fitting, assembly, air inlet, NIST
16144	Fitting, assembly, air inlet, air liquide
16173	Fitting, assembly, air inlet, male DISS
16131	Fitting, assembly, heliox and air, DISS
16132	Fitting, assembly, heliox and air, NIST
16149	Fitting, assembly, heliox and air, air liquide
16174	Fitting, assembly, heliox and air, male DISS

AVEA consumables



51000-40094
AVEA adult flow sensor
Single patient use, each

50000-40031
AVEA adult flow sensor
Single patient use, pack of 10

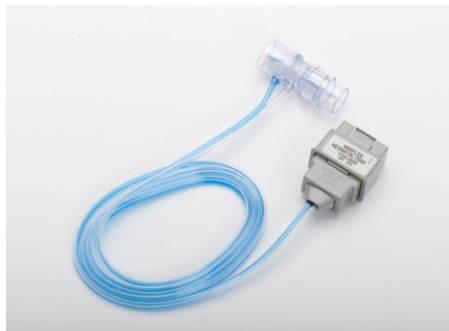

51000-40098
AVEA neonatal flow sensor
Single patient use, each

50000-40038
AVEA neonatal flow sensor
Single patient use, pack of 10



11395
AVEA exhalation filter
Single patient use, box of 12



11790
AVEA expiratory filter water trap
Single patient use, box of 12

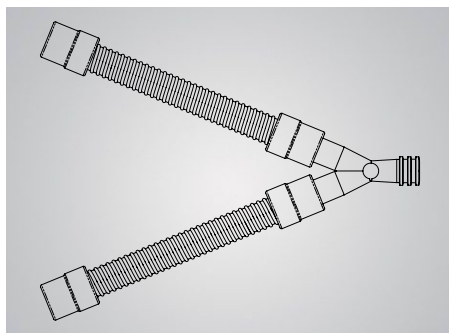

16044
Patient breathing circuit kit, 48"

16045
Patient breathing circuit kit, 72"

AVEA esophageal pressure monitoring consumables



7003100
Esophageal pressure monitoring tube set
8 Fr, adult
Single patient use, box of 10

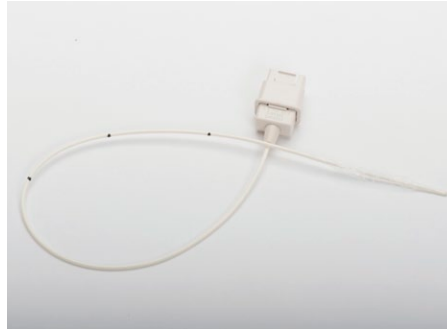

7003401
Esophageal pressure monitoring tube set
6 Fr, pediatric
Single patient use, box of 10

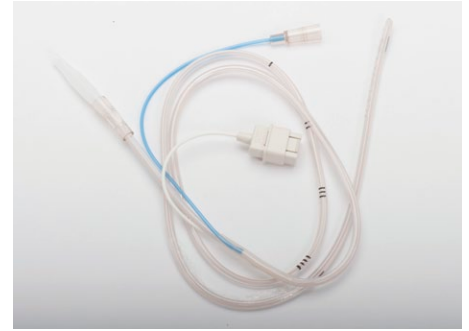

7003300
Adult nasogastric esophageal pressure monitoring tube
16 Fr, with esophageal balloon
Single patient use, box of 10



7003402
Pediatric nasogastric esophageal pressure monitoring tube
7 Fr, with esophageal balloon
Single patient use, box of 10

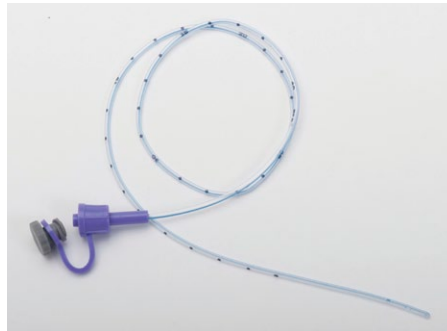

79018
Tracheal monitoring tube
Single patient use, each

10635
Tracheal monitoring tube
Single patient use, box of 10



50000-09960
Extension esophageal pressure monitoring tube
Single patient use, each

50000-09920
Extension esophageal pressure monitoring tube
Single patient use, box of 10



50000-40034
Tracheal catheter adapter
Single patient use, box of 10

AVEA volumetric capnography accessories



11732
Capnography hardware upgrade kit
Capnostat® 5 sensor cable (PN 27695-001), disposable sensors (PN 16605 and 16606) and (PN 63733) Capnography software key included. Ventilator software 4.1 or newer only



27695-001
Capnostat® 5 sensor cable
CO₂ sensor assembly
Reusable, each



16605
CO₂ adapter, adult/pediatric
Single patient use, box of 10



16606
CO₂ adapter, neonatal
Single patient use, box of 10



16607
CO₂ adapter, adult/pediatric
Reusable, each

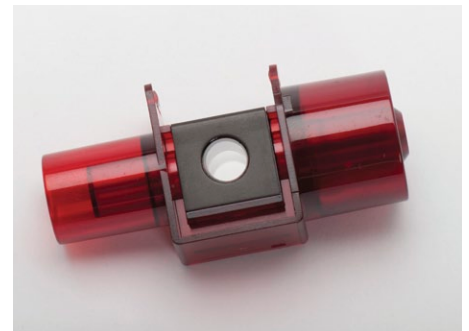

16608
CO₂ adapter, neonatal
Reusable, each

VELA® ventilator products



VELA accessories

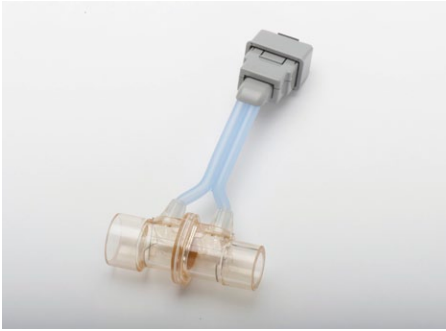

16496
VELA Diamond flow sensor
Reusable, each



16240D
VELA Diamond exhalation valve diaphragm
Reusable, pack of 10



10384D
VELA II exhalation valve diaphragm
Reusable, pack of 10

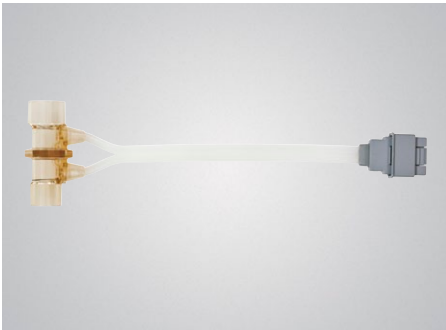

15972
VELA II flow sensor
Reusable, each



20005
Exhalation valve body
(VELA II and Diamond) Reusable, each



15619
Nurse call cable open



12194
Oximeter mount
For use with transport stand
(PN 11540 or 15987 only)

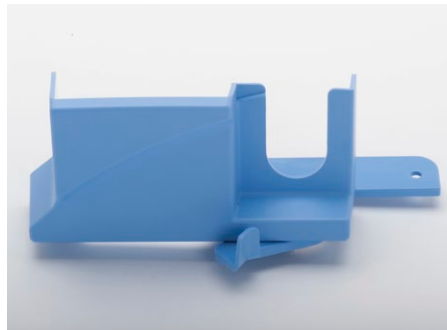

11539
Exhalation outlet cover kit
For use ONLY with VELA Diamond series,
stands (PN 11536 or PN 11540), and
flow sensor (PN 16496)



15620
Nurse call cable closed



11540
Transport stand
(Includes support arm PN 69300)

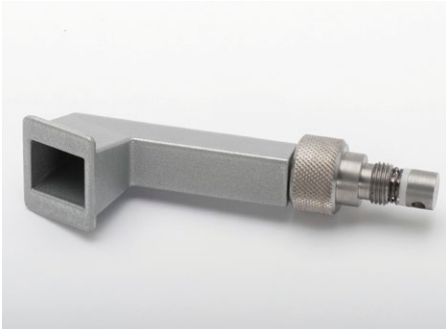

11938
Aeroneb nebulizer stand mounting kit



69300
Circuit support arm



34403
Circuit support arm (PN 69300) circuit holder
Pack of 3



11536
Basic stand
Support arm not included



21782
Cylinder rings
For use with transport stand (PN 11540)



21773
Basic breakdown stand
Pole, base and casters



21778
Handle
For use with PN 21773



21774
Adapter mounting plate
For use with PN 21773



21775
Adapter mounting post
For use with PN 21773



21780
IV pole



40624
Screw
For use with transport stand (PN 11540)



45038
Split washer
For use with transport stand screw
(PN 40624)

VELA capnography accessories



27695-001
Capnostat® 5 sensor cable
CO₂ sensor assembly
Reusable, each



16605
CO₂ adapter, adult/pediatric
Single patient use, box of 10



16607
CO₂ adapter, adult/pediatric
Reusable, each



17509
Partial capnography upgrade kit
Included: Power box (PN 16546),
Capnostat 5 sensor cable (PN 27695-001),
box of 10 single patient use adult/pediatric
CO₂ adapters (PN 16605)
Does not include capnography activation
software.



16546
Capnography power box/monitor interface

16920
Full capnography upgrade kit
Included: Power box (PN 16546),
Capnostat 5 sensor cable (PN 27695-001),
box of 10 single patient use adult/pediatric
CO₂ adapter (PN 16605)
Includes capnography software with
activation.

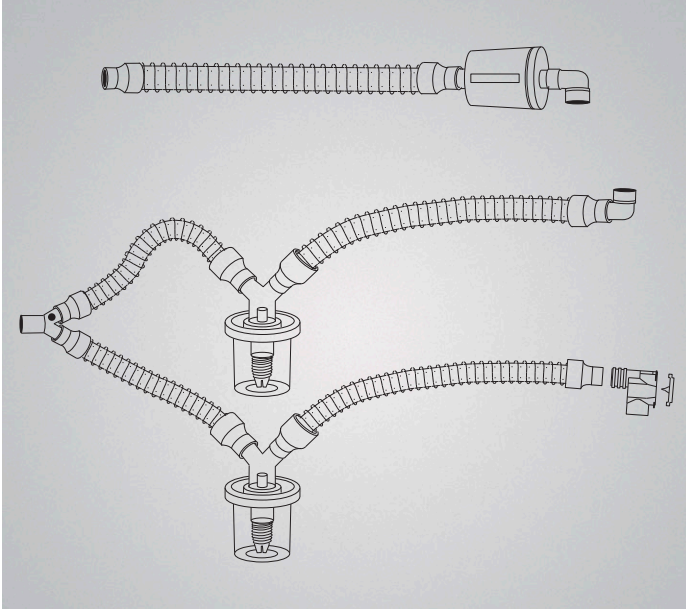

11571

VELA Diamond pediatric breathing circuit kit

Included: Circuit tubing, 18" smooth bore; main flow bacteria filter; 90° elbow adapter; 22 mm ID cuff adapter; circuit tubing, 30" smooth bore; watertrap, autoclavable; tapered plug, 7.5 mm male; wye connector; exhalation valve body; Diamond exhalation valve diaphragm

11570

VELA Diamond adult breathing circuit kit

Included: Circuit tubing, 18" smooth bore; main flow bacteria filter; 90° elbow adapter; 22 mm ID cuff adapter; circuit tubing, 30" smooth bore; watertrap, autoclavable; tapered plug, 7.5 mm male; wye connector; exhalation valve body; Diamond exhalation valve diaphragm

10684

VELA II adult breathing circuit kit

Included: Circuit tubing, 18" smooth bore; main flow bacteria filter; 90° elbow adapter; 22 mm ID cuff adapter; circuit tubing, 30" smooth bore; watertrap, autoclavable; tapered plug, 7.5 mm male; wye connector; exhalation valve body; VELA II exhalation valve diaphragm

Cat. no.	Description
09531	Circuit tubing, 30" smooth bore (use 09531D for a pack of 10)
09532	Circuit tubing, 18" smooth bore (use 09532D for a pack of 10)
09534	Main flow bacteria filter
04709	90° elbow adapter
09413	Watertrap, autoclavable
4124	Tapered plug, 7.5 mm male
20225	Wye connector
00423	22 mm ID cuff adapter (use 00423D for a pack of 10)

EnVe[®] ventilator products

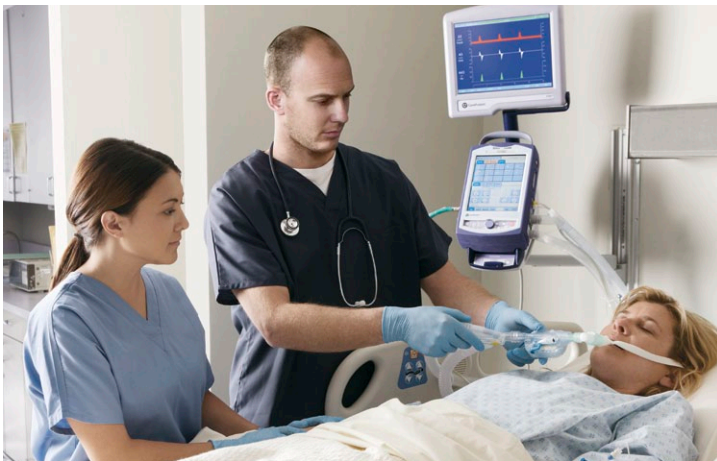
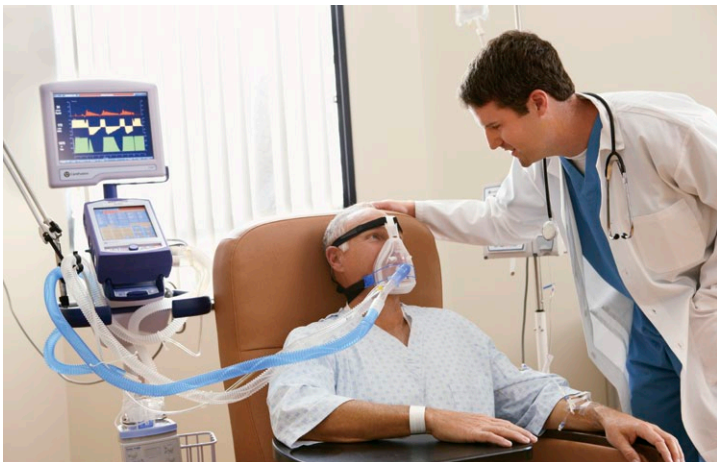



19270-001
 Docking station, protective cover, power cord and operator manual



21380-001
 Protective collar, docking station



24737-001
 PTV® Transport Bracket for bed rail and pole mounting. Includes PalmTop™ mounting accessory and clamp.
 Packaged preassembled.



24736-001
 PTV Transport Bracket for L-Track mounting. Includes PalmTop mounting accessory and semi-permanent hardware.
 Assembly required.



004-13914-001
 PTV stand O₂ cylinder basket holder



004-12140-001
 PTV patient circuit support arm



004-13886-001
 PTV wall mount humidifier pole



004-18862-001
 PTV wall mount (purple)
 Circuit support arm kit (PN 004-13885-001) included

EnVe accessories



004-19937-001
PTV mounting base
For use with docking station
(PN 004-19270-001)



004-19574-001
PTV desktop mounting stand



004-12103-001
PTV AC adapter power kit
AC adapter and power cord included



004-13955-001
PTV desktop battery charger
with 110 VAC power cord
(batteries not included)



004-13908-001
PTV lithium-ion
Hot-swappable battery
Each



004-19495-001
PTV protective collar, replacement kit



004-19833-001
PTV fan filter
Pack of 10



004-13063-001
PTV VOXP data adapter and cable



004-19826-001
PTV air inlet filter
Each



004-12695-002
PTV carry case



004-12102-001
PTV automobile charger
Each



004-18602-001
SpO₂ module
Cable only, each



004-19461-001
SpO₂ clip sensor, pediatric
Reusable, each



004-13035-001
SpO₂ clip sensor, adult
Reusable, each

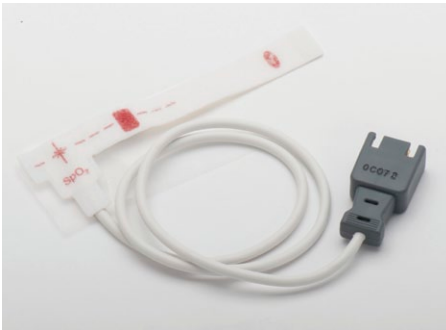

004-19462-001
SpO₂ reflectance sensor
Each

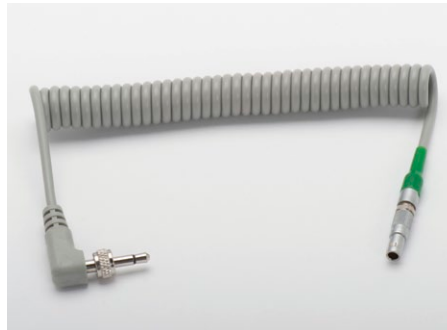

004-13897-001
PTV cable, FiO₂
Each



004-13036-001
FiO₂ sensor
Each



004-13037-001
FiO₂ sensor T piece
Reusable, each



004-13038-001
FiO₂ sensor T piece
Single patient use, box of 10

Ventilator accessories sold but not shown

Cat. no.	Description	Qty.
004-13912-001	PTV roll stand includes circuit support arm (P/N 004-12140-001)	Each
004-19463-001	SpO ₂ Flexi-Form II, adult, single patient use	Box of 10
004-19464-001	SpO ₂ Flexi-Form II, pediatric, single patient use	Box of 10
004-19465-001	SpO ₂ Flexi-Form II, infant, single patient use	Box of 24
004-19827-001	Exhalation diaphragms, kit	Pack of 10
004-19828-001	Expiratory port, kit	Each

EnVe circuits

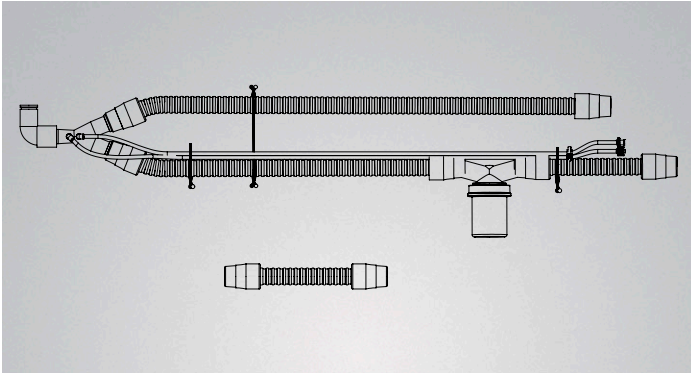

004-18220-001
Patient circuit adult
Non-heated
Reusable, each

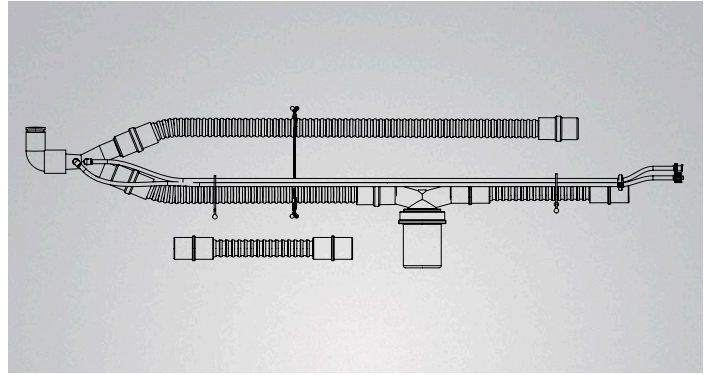

004-18227-001
Patient circuit pediatric
Non-heated
Reusable, each

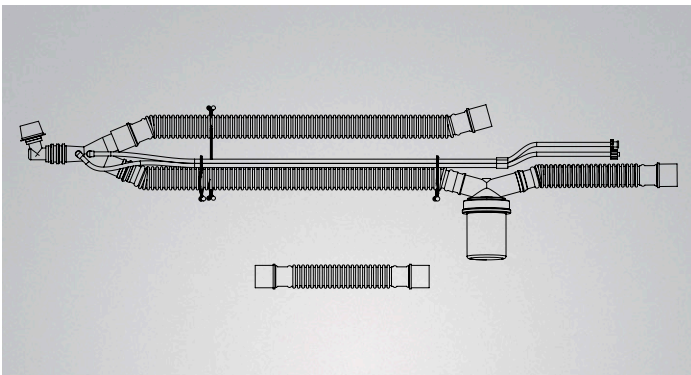

004-18221-101
Patient circuit adult
Non-heated
Single patient use, box of 10

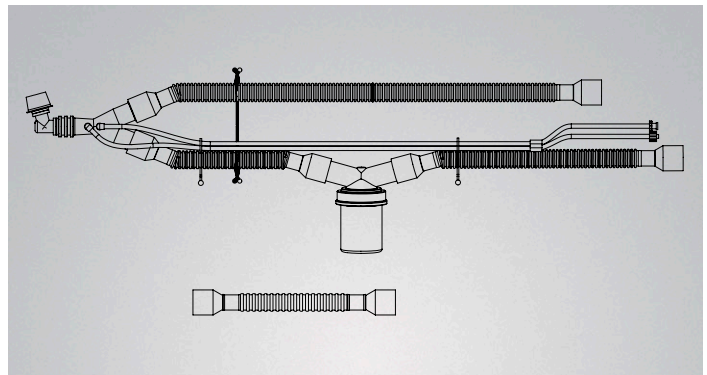

004-18228-101
Patient circuit pediatric
Non-heated
Single patient use, box of 10

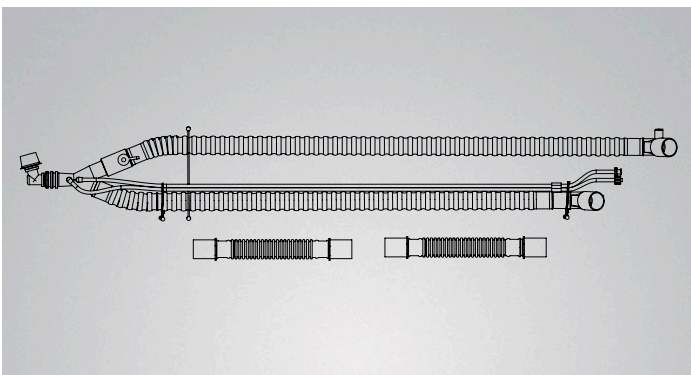

004-18223-101
Fisher & Paykel MR850 humidifier
Patient circuit adult, dual heated limb
Single patient use, box of 10

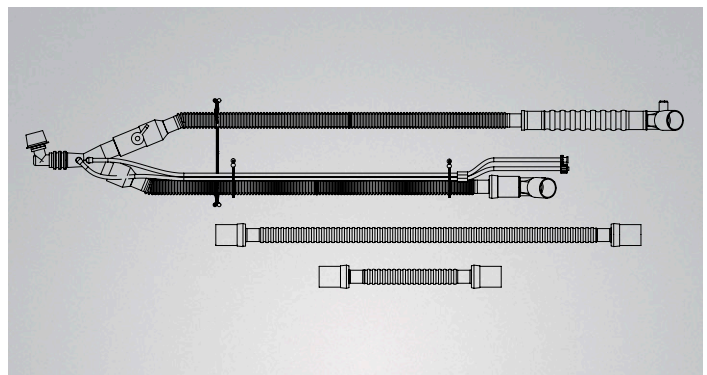

004-18230-101
Fisher & Paykel MR850 humidifier
Patient circuit pediatric, dual heated limb
Single patient use, box of 10

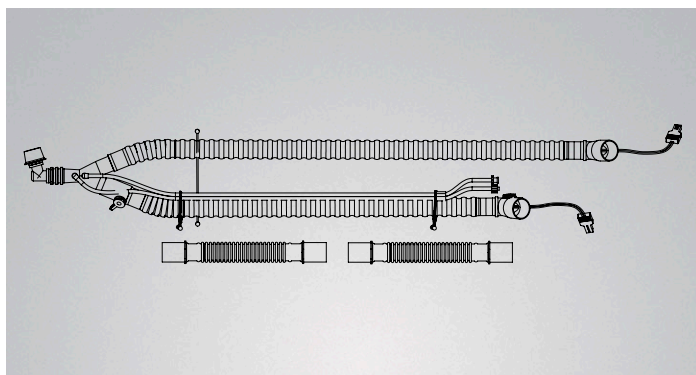

004-19211-001
Teleflex patient circuit adult
Dual heated limb
Single patient use, box of 10

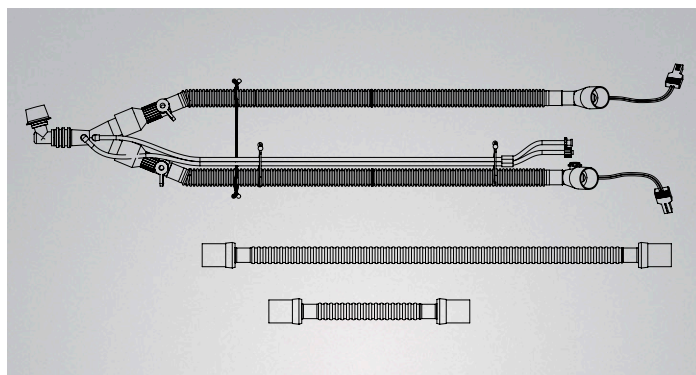

004-19212-001
Teleflex, patient circuit pediatric
Dual heated limb
Single patient use, box of 10



004-18225-001
Patient circuit wye with flow sensor
Reusable, each

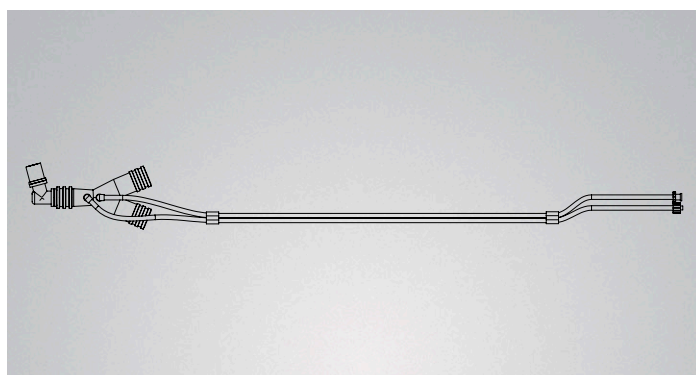

004-18226-101
Patient circuit wye with flow sensor
Single patient use, box of 10

Bird® Blender products





03800A
High flow MicroBlender without hoses



10030A
MRI high flow MicroBlender without hoses



03803T
OmniBlender without hoses, triple outlet



UltraBlender low flow



03920A
Low flow MicroBlender without hoses
DISS



15625
Sentry Blender/Analyzer, high flow
DISS, without hoses

Cat. no.	Description
10040A	0.15–1.0/2–16 LPM, DISS
10041A	0.5–5.0/2–16 LPM, DISS
10042A	1.0–10.0/2–16 LPM, DISS
10046A	2–16/2–16 LPM, DISS
10047A	0.15–1.0/1.0–10.0 LPM, DISS
10048A	0.5–5.0/1.0–10.0 LPM, DISS
10049A	1.0–10.0/1.0–10.0 LPM, DISS

16694A
Sentry Blender/Analyzer, low flow
DISS, without hoses

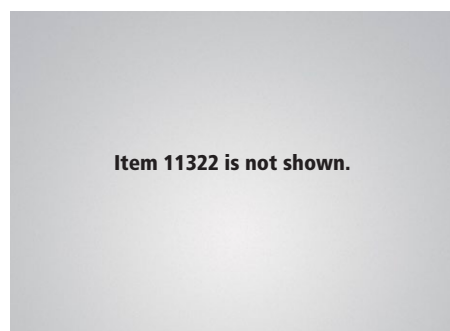

Item 11322 is not shown.

11322
Low flow blender with 2-16 LPM flow meter
DISS

Bird Blender accessories



2688-332
90° elbow adapter



66045
Oxygen sensor, galvanic with flow diverter
For 15 mm port



09220
Flowmeter, 0–15 LPM oxygen
DISS, male



07426
Air inlet water trap/filter assembly



03869H
Auxiliary assembly outlet
9/16–18, 03800



04322
Pole mount blender bracket



05141
Female dovetail bracket



05213
Female dovetail wall bracket



09437
Rail mount blender bracket



09440
Rail mount bracket



01468
Connector
9/16" (3-way), 2 male and 1 female



03837
Connector, tailpiece
Oxygen, 7/16-27



20254
Connector, inlet, air, MicroBlender
NIST



20255
Connector, inlet, oxygen, MicroBlender
NIST



32042
Adapter, oxygen
DISS x 1/4" tube

3100A and 3100B High-Frequency Oscillatory Ventilator (HFOV) products





467377
Fisher & Paykel humidifier MR850
 115 V, with capital orders only
69754
Fisher & Paykel humidifier MR850
 230 V, with capital orders only



768965
Humidifier mounting bracket
 For use with Teleflex



768968
Humidifier mounting bracket
 For use with Fisher & Paykel MR730 and MR850



770134
Fisher & Paykel autofeed pole



770135
Adapter bracket
 For use with Fisher & Paykel humidifier base and autofeed pole



770136
Fisher & Paykel
 Autofeed pole and bracket kit

Blender and accessories



10273
Blender kit
 One blender, air tee/hose assembly and gas output hose



10112
Air tee/hose assembly

Blender and accessories items sold but not shown

Cat. no.	Description
463605	Hose, oxygen (green)
463606	Hose, air (yellow)
9220	Flow meter 0–15 LPM DISS

3100A and 3100B HFOV accessories



766586
Driver cover plate



770566
Circuit cradle



767138
Support arm for use with adjustable cradle



462364
Thumb screw for support arm and cradle

Accessories and service items sold but not shown.

Cat. no.	Description	Qty.
765742	Circuit hold down strap	Each
767163	Air inlet filter element	Pack of 10
766798	Column lint filter element	Each
465298	Krytox inert grease	2 oz. tube
765759	3100A HFOV patient circuit calibration label	Each
772754	3100B HFOV patient circuit calibration label	Each

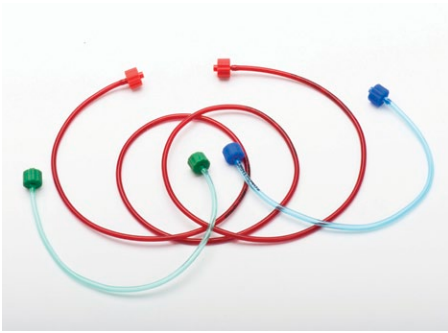

11437
Connecting tubing set, unfiltered circuits
Red, blue and green tubing
Each

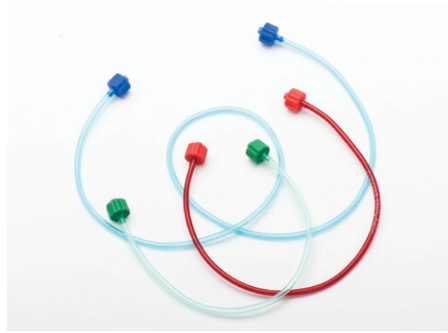

11438
Connecting tubing set, filtered circuits
Red, blue and green tubing
Each



766897
Bellows and water trap set
Box of 4



766896
Cap diaphragm set
Box of 4



12151
Inspiratory filters
Box of 12



12152
Expiratory filters
Box of 25



480029
Circuit port adapter for nitric oxide sampling



772793
Exhaled gas deflector

Unfiltered circuits



Cat. no.	Description	Qty.
771374	Fisher & Paykel MR730 humidifier flexible circuit with short heated wire <i>(for heated environment)</i>	Box of 4
771375	Fisher & Paykel MR730 humidifier flexible circuit with long heated wire <i>(for non-heated environment)</i>	Box of 4
773996	Fisher & Paykel MR850 humidifier flexible circuit with short heated wire <i>(for heated environment)</i>	Box of 4
773997	Fisher & Paykel MR850 humidifier flexible circuit with long heated wire <i>(for non-heated environment)</i>	Box of 4
771463	Teleflex 380-90/ConchaTherm III humidifier 16 V, flexible circuit with short heated wire <i>(for heated environment)</i>	Box of 4
771465	Teleflex 380-88/ConchaTherm IV humidifier 21 V, flexible circuit with short heated wire <i>(for heated environment)</i>	Box of 4
771466	Teleflex 380-88/ConchaTherm IV humidifier 21 V, flexible circuit with long heated wire <i>(for non-heated environment)</i>	Box of 4

Unfiltered circuits sold but not shown

Cat. no.	Description	Qty.
766895	Rigid patient circuit body without heated wire	Box of 4

Filtered circuits



Cat. no.	Description	Qty.
11518-730S	Fisher & Paykel MR730 humidifier flexible filtered circuit with short heated wire <i>(for heated environment)</i>	Box of 4
11518-730L	Fisher & Paykel MR730 humidifier flexible filtered circuit with long heated wire <i>(for non-heated environment)</i>	Box of 4
11518-850S	Fisher & Paykel MR850 humidifier flexible filtered circuit with short heated wire <i>(for heated environment)</i>	Box of 4
11518-850L	Fisher & Paykel MR850 humidifier flexible filtered circuit with long heated wire <i>(for non-heated environment)</i>	Box of 4
11518-16VS	Teleflex 380-90/ConchaTherm III humidifier 16 V, flexible filtered circuit with short heated wire <i>(for heated environment)</i>	Box of 4
11518-21VS	Teleflex 380-88/ConchaTherm IV humidifier 21 V, flexible filtered circuit with short heated wire <i>(for heated environment)</i>	Box of 4
11518-21VL	Teleflex 380-88/ConchaTherm IV humidifier 21 V, flexible filtered circuit with long heated wire <i>(for non-heated environment)</i>	Box of 4

Notes:

Short heated wires are for heated environments, such as radiant warmers or isolettes.
Long heated wires are for unheated environments, such as cribs, bassinet or beds.

Unfiltered circuits

Pre-packaged kit for all required supplies—circuit, bellows, water trap, cap diaphragms and connecting tubing. Box of four complete kits. Humidifier chamber not included.



Cat. no.	Description	Qty.
11744-730K	Fisher & Paykel MR730 humidifier flexible circuit with heated wire kit	Box of 4
11744-850K	Fisher & Paykel MR850 humidifier flexible circuit with heated wire kit	Box of 4
11744-HRCK	Teleflex 380-88, ConchaTherm IV (21 V), flexible circuit with heated wire, Teleflex ConchaTherm III/IV kit	Box of 4

Filtered circuits

One inspiratory and expiratory filter and a cap diaphragm set. Expiratory filter needs to be changed every 24 hours. Inspiratory filter does not need routine changing.



Cat. no.	Description	Qty.
16390-101	Fisher & Paykel MR730 humidifier flexible filtered circuit with heated wire	Box of 4
16390-102	Fisher & Paykel MR850 humidifier flexible filtered circuit with heated wire	Box of 4
16390-103	Teleflex 380-88, ConchaTherm IV (21 V) flexible filtered circuit with heated wire	Box of 4

Infant Flow® nCPAP products





777237-101
 Infant Flow SiPAP stand with IV pole
 and basket
777237-102
 Infant Flow SiPAP stand with basket only



777238
IV pole, only
 For use with SiPAP stand



777243
**Fisher & Paykel MR730 and MR850
 humidifier bracket**



467377
Fisher & Paykel MR850 humidifier
 115 V, with capital orders only



466423
**Fisher & Paykel MR730 and MR850
 humidifier pole clamp**



770135
Fisher & Paykel Pole mounting bracket
 For attaching auto feed pole



770136
Fisher & Paykel auto feed pole
 For use with MR850 humidifier



770134
Fisher & Paykel auto feed pole
 For use with MR730 humidifier

Infant Flow SiPAP accessories



466952
Fisher & Paykel MR850 heated wire adapter ("pigtail")

480044
Fisher & Paykel MR559
Heated wire adapter MR730

480038
Fisher & Paykel humidifier adapter kit



467375
Fisher & Paykel MR850 temperature probe
Dual right angle, 72"

467376
Fisher & Paykel MR850 temperature probe
Dual right angle 60"

772211
Fisher & Paykel MR730 temperature probe
Dual right angle, 72"



777248
Teleflex humidifier bracket
Neptune or RCI ConchaTherm humidifier

466448
Teleflex humidifier pole mount clamp
ConchaTherm humidifier



467349
Infant Flow respiratory abdominal sensors
Single patient use, box of 25



677-002
Infant Flow SiPAP transducer assembly



D1420/100
Infant Flow baffle/filter
Single patient use, box of 20



777215
Infant Flow extension tube
Single patient use, pack of 10



775728
Infant Flow bonnet straps
Single patient use, pack of 20



777200LP

Infant Flow LP generator kit without nasal prongs

Included: Dual-jet, variable flow generator and sizing guide

Single patient use, box of 10



777202LP

Infant Flow LP generator kit with nasal prongs

Included: Dual-jet, variable flow generator, sizing guide and small, medium and large nasal prongs

Single patient use, box of 10



7772010

Infant Flow LP starter kit

Included: 5 Infant Flow LP generator kits with S, M, L prongs; 2 XS, S, SM, M, L and XL headgear sizes; 2 XS, S, SM, M, L and XL nasal masks sizes; 2 XL nasal prongs; and 2 XS nasal prongs

Single patient use



7772011

Infant Flow LP generator kit/Fisher & Paykel MR730 or MR850 breathing circuit

Included: Infant Flow LP generator kit with prongs and neonatal, single-limb, heated breathing circuit

Single patient use, box of 10

7772021

Infant Flow LP generator kit/Fisher & Paykel MR730 or MR850 breathing circuit

Included: Infant Flow LP generator kit with nasal prongs and neonatal, single-limb, heated breathing circuit

Single patient use, box of 20



Nasal masks

For use only with the Infant Flow LP generator

Single patient use, pack of 10

Cat. no.	Color	Size
777002XS	Green	Extra small
777002S	Pink	Small
777002M	Blue	Medium
777002L	Purple	Large
777002XL	Clear	Extra large



Nasal prongs

For use only with the Infant Flow LP generator

Single patient use, pack of 10

Cat. no.	Color	Size
777000XS	Green	Extra small
777000S	Pink	Small
777000M	Blue	Medium
777000L	Purple	Large
777000XL	Clear	Extra large

Infant Flow LP headgear and bonnets

Headgear

For use with the Infant Flow LP generator assembly
Single patient use



Cat. no.	Size	Measurements	Qty.
777040XS	Extra small	17–21 cm	Box of 10
777040S	Small	21–26 cm	Box of 10
777040SM	Small-medium	24–28 cm	Box of 10
777040M	Medium	26–32 cm	Box of 10
777040L	Large	32–37 cm	Box of 10
777040XL	Extra large	37–42 cm	Box of 10

Bonnets

Single patient use

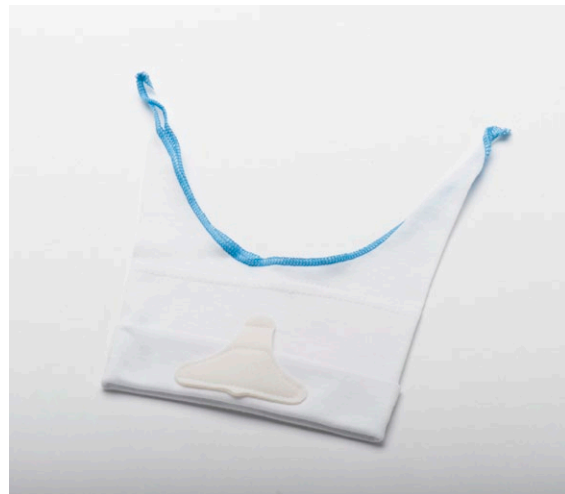
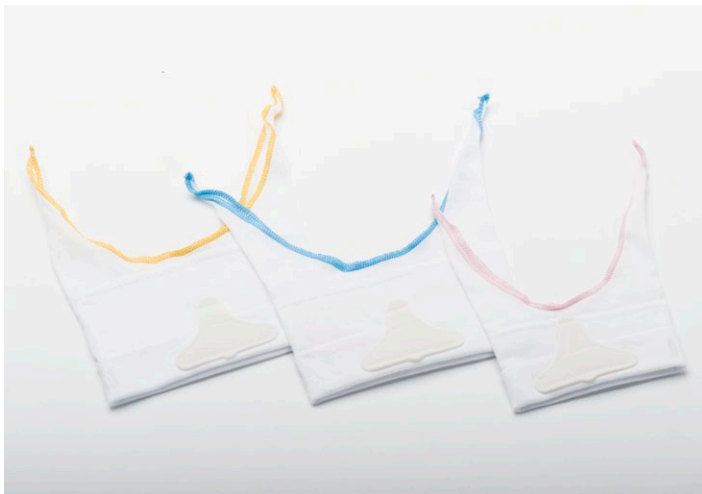

Cat. no.	Size	Color	Measurements	Qty.
777010	000	White	18–20 cm	Pack of 10
777012	00	Gray	20–22 cm	Pack of 10
777014	0	Pink	22–24 cm	Pack of 10
777016	1	Lt. brown	24–26 cm	Pack of 10
777018	2	Yellow	26–28 cm	Pack of 10
777020	3	Lt. blue	28–30 cm	Pack of 10
777022	4	Gold	30–32 cm	Pack of 10
777024	5	Green	32–34 cm	Pack of 10
777026	6	Lt. burgundy	34–36 cm	Pack of 10
777028	7	Orange	36–38 cm	Pack of 10

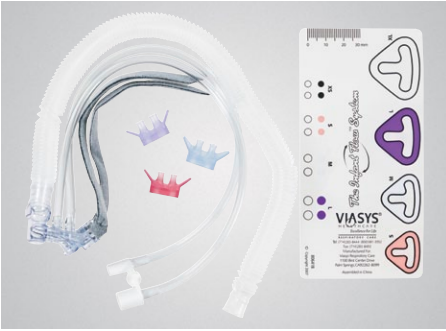

777085-102

Infant Flow generator kit/circuit

Included: Generator, sizing guide and small, medium and large nasal prongs

Single patient use, case of 20

12204-102

Infant Flow generator kit/circuit

Included: Generator, prongs and Fisher & Paykel neonatal, single-limb heated circuit for use with MR730 or MR850 humidifier

Single patient use, case of 20

773389-104

Infant Flow generator kit/circuit

Included: Generator, prongs and neonatal, single-limb heated circuit for use with Hudson RCI humidifiers (21V)

Single patient use, box of 20



Nasal masks

For use only with the Infant Flow generator assembly

Single patient use

Cat. no.	Size	Qty.
777086-101	Small	Box of 10
777086-102	Medium	Box of 10
777086-103	Large	Box of 10
777086-104	Extra large	Box of 10



12204-101

Infant Flow circuit only

Fisher & Paykel neonatal, single-limb heated circuit for use with MR730 or MR850 humidifier

Single patient use, case of 20

773389-105

Infant Flow circuit only

Neonatal, single-limb heated circuit for use with Hudson RCI humidifiers (21V)

Single patient use, box of 20



Nasal prongs

For use only with the Infant Flow generator assembly

Single patient use

Cat. no.	Size	Qty.
11513-101	Small	Box of 10
11513-102	Medium	Box of 10
11513-103	Large	Box of 10



Bonnets

For use only with the Infant Flow generator assembly

Single patient use, pack of 10

Cat. no.	Size	Color	Measurements
777084-101	000	White	18–20 cm
777084-102	00	Gray	20–22 cm
777084-103	0	Pink	22–24 cm
777084-104	1	Lt. brown	24–26 cm
777084-105	2	Yellow	26–28 cm
777084-106	3	Lt. blue	28–30 cm
777084-107	4	Gold	30–32 cm
777084-108	5	Green	32–34 cm
777084-109	6	Lt. burgundy	34–36 cm
777084-110	7	Orange	36–38 cm
777084-111	8	Dk. green	38–40 cm
777084-112	9	Navy	40–42 cm



CareFusion
Yorba Linda, CA

carefusion.com/criticalcare



CareFusion