



CARDIOVASCULAR & CRITICAL CARE SOLUTIONS PRODUCT CATALOG



TABLE OF CONTENTS

4	PRESSURE MONITORING
28	THERMODILUTION & PULMONARY ARTERY CATHETERS
32	CENTRAL VENOUS CATHETERS
38	ARTERIAL CATHETERS AND HEMOSTASIS
42	FLUID MANAGEMENT
59	TUBING
62	SAFETY & INFECTION CONTROL
77	COMPLETE PROCEDURAL SOLUTIONS
86	ACCESSORIES

IT ALL BEGAN with the coronary control syringe. The rest is history.

In 1987, Merit Medical pioneered a clear-as-glass polycarbonate syringe to reduce the risk of a glass syringe breaking in the hand of a healthcare provider. Since our beginning, we've consistently prioritized solutions to your procedural challenges, with the goal of making your job safer, more accurate and more efficient. We believe that when you have the right tools to do your job well, it results in better patient care.

Merit Medical's comprehensive Cardiovascular and Critical Care (CCC) product portfolio, presents these healthcare solutions. This includes custom kits that decrease set-up time and reduce waste, as well as products like blood pressure monitoring systems for the ICU and CICU that enhance the accuracy of patient care. Our products like the Futura® Safety Scalpels and Advance® Safety needles aim to prevent workplace injury, while our infection control solutions like the BackStop+™ Disposal System, the DualCap® Disinfection System, and the Safedraw® closed arterial blood sampling kits reduce contaminant exposure for both you and your patients.

In addition to the benefits each of these products provide, partnering with Merit Medical will ensure that healthcare providers can rely on product consistency across the entire continuum of patient care.

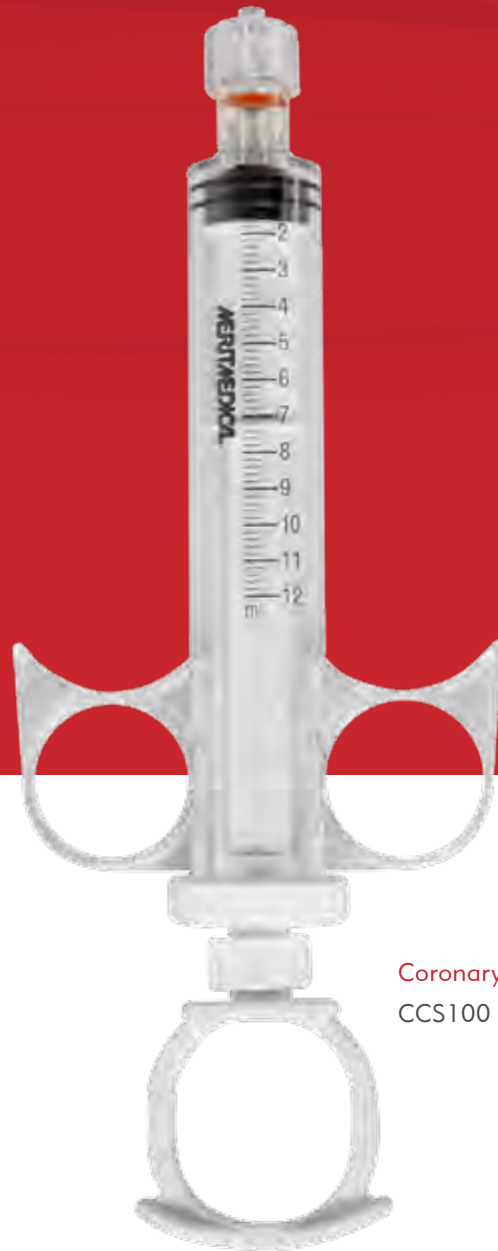

Coronary Control Syringe
CCS100



PRESSURE MONITORING

PRESSURE MONITORING

- 5 DTXPlus® Disposable Pressure Transducers and Transducer Sets**
- 9 DTXPlus® with the Safedraw® Closed Arterial Sampling System**
- 10 MeritTrans® Pressure Transducer Sets - Cardiac Catheterization Kit Configurations**
- 14 TRAM® – Compensating Manifold with Integrated Transducer**
- 15 TRAM-P™ – Compensating Manifold with Integrated Transducer + PM Tubing**
- 16 ArgoTrans™**
- 17 ArgoTrans™ Keepsafe™ Closed Sampling Transducer Kits**

ACCESSORIES

- 18 DTXPlus® Accessories and Cables**
- 24 MeriTrans® Accessories and Cables**
- 27 ArgoTrans™ Accessories**

DTXPlus® Disposable Transducer Overview

Merit DTXPlus Pressure Transducers are designed to simplify clinical workflow while providing safe and precise patient monitoring. The following features are integrated into select transducer sets to simplify device operation and enhance patient care:

- **Safedraw®** - A closed blood draw system designed to optimize sample purity and quality while keeping your patients free from harmful pathogens.
- **EasyVent®** - A unique luer lock cap that allows clinicians to prime and zero the stopcock without removing the cap and exposing the system to the ambient environment.
- **Gabarith™ Tested** - Pressure monitoring accuracy depends on the entire monitoring system. The Gabarith test is a scientific technique to measure the performance of the entire monitoring system - transducer, set, stopcocks, filter, and the catheter. This test achieves the quality standard set by the Association for the Advancement of Medical Instrumentation (AAMI). Noted sets have been Gabarith tested.

Merit Pressure Transducers are latex-free, non-pyrogenic, and are offered in multiple configurations to meet critical care needs.

DTXPLUS® DISPOSABLE PRESSURE TRANSDUCER SETS SPECIFICATIONS

DETAIL	DTXPLUS® SPECIFICATIONS
Environmental performance: a) storage temperatures b) operating temperatures c) humidity d) atmospheric pressure	-25°C to 70°C 15°C to 40°C 10% to 90% 425 to 850 torr
Pressure range: a) operating pressure b) overpressure withstand	-30 to 300 mmHg -700 to 7,755 mmHg
Mounting requirement:	Will meet performance requirements when mounted on any axis
Frequency response (Stand-alone Transducer):	15% bandwidth shall be >200 Hz
Transducer excitation:	DC to 5,000 Hz 4 to 8 V RMS
Phase shift:	<5°
Transducer excitation impedance (input impedance):	>200 ohms
Transducer signal impedance (output impedance):	<3,000 ohms
Transducer symmetry:	±5%
Nominal sensitivity (gain):	5 μ V/V/mmHg
Unbalance (zero balance):	±40 mmHg
Accuracy:	The maximum error due to the total effects of nonlinearity, hysteresis and sensitivity variations shall be no more than 2% of the reading or \pm 1 mmHg, whichever is greater, over the operating range.
Risk current:	<2 μ A
Defibrillator withstand:	Withstand five repeated discharges in 5 minutes of 400J sinusoidal energy delivered into 50 ohms when all transducer wires are shorted and saline is in fluid column
Requirements for the cable: a) cable length stated b) transducer venting to atm. c) cable will withstand five repeated discharges in 5 minutes of 360J sinusoidal energy delivered into 50 ohms when all wires are shorted and foil surrounds the cable	Cable length stated Venting to atmosphere Withstand five repeated discharges in 5 minutes of 400J sinusoidal energy delivered into 50 ohms when all wires are shorted and foil surrounds the cable
Flow Rate, DTXPlus transducers:	2 – 4 cc/hr or 20 – 40cc/hr, depending on model, with an infusion pressure (difference) of 200mmHg.
Fast Flush Rate, DTXPlus transducers:	Min 50cc/min using a microdrip administration set with 60 inch of IV tubing with an infusion pressure (difference) of 200mmHg.
DTXPlus Transducer dimensions (inc Flush and Zero stopcock):	Max Length: 8.4cm (Inc zero stopcock and male luer fitting); Max Width: 3.2cm; Max Height: 3cm (Inc EasyVent® Deadender on Zero stopcock). Length of Transducer electric cable: 34.5cm

DISPOSABLE PRESSURE TRANSDUCERS



DTXPlus®
 Disposable Pressure Transducers
 Sterile, single use

PRODUCT CODE	DESCRIPTION	BOX/CASE CONTENT (UNITS)
682018	Disposable transducer with Critiflex™ integral flush device and stopcock (3cc/hr nominal flow rate)	10/100
682019	Disposable transducer for neonatal/pediatric uses, used in conjunction with a mechanical infusion pump (max. 30cc/hr flow rate)	10/100
682020	Disposable transducer with integral flush device without stopcock (3cc/hr nominal flow rate)	10/100
682021	Disposable transducer without integral flush device or stopcock, suitable for cardiology/neurology applications	10/100





DTXPlus®

Disposable Transducer Sets with EasyVent®

Sterile, single use

DISPOSABLE TRANSDUCER SETS FOR THE INVASIVE MONITORING OF HEMODYNAMIC PRESSURE

PRODUCT CODE	DESCRIPTION	LENGTH	TUBING COLOR	UNITS PER BOX/CARTON
682000	60' Microdrip Transducer Kit for Pole-Mount Application	120/30 cm	Clear	5/50
682002	 Gabarith™ Tested, 50" single disposable transducer set	125/25 cm	Clear	5/50
682003	60" transducer set	120/30 cm	Clear	5/50
682007	60" Dual Line Macrodrip Transducer Kit for Pole-Mount Application	2 x 120/30 cm	Clear	5/25
682012	60" Triple Line Microdrip Transducer Kit for pole-mount application	3 x 120/30 cm	Clear	5/25
682014	72' Microdrip Transducer kit for pole-mount application	150/30 cm	Clear	5/50
682016	84" transducer set	30/180 cm		5/50
682017	 Gabarith™ Tested 50" Transducer set	2 x 125/25 cm	Clear	5/25
682024	12' Microdrip Transducer Kit for Patient Mount Application	30 cm	Clear	5/50
682026	36" transducer set	90 cm	Clear	5/50
682028	Triple line 60" Macrodrip transducer set for pole mounted applications	2 x 120/30 cm	Clear	5/25
682034	60" Macrodrip transducer set	120/30 cm	Clear	5/50
682035	72" Macrodrip transducer set	150/30 cm	Clear	5/50
682133	60" transducer set with R.O.S.E. Admin set	120/30 cm	Clear	5/25
682147	Dual line 60" Macrodrip transducer set for pole mounted applications	2 x 120/30 cm	Clear	5/15
682286	60" Dual Line Macrodrip Transducer Kit for Pole-Mount Application	2 x 120/30 cm	Blue / Yellow	5/25

DISPOSABLE PRESSURE TRANSDUCER SETS



DTXPlus[®] Pediatric and Neonatal Disposable Transducer Sets

Sterile, single use

PRODUCT CODE	DESCRIPTION	LENGTH	TUBING COLOR	UNITS PER BOX/CARTON
682019	Transducer without built in flush and zero stopcock (Max 30 mL/Hr flow rate). Only for use with a mechanical infusion pump	N/A	N/A	10/100
682040	Transducer with 12" pediatric tubing and two distal white stopcocks (Max 30 mL/Hr flow rate). Only for use with a mechanical infusion pump	30 cm	Clear	10/100



DTXPlus[®] with the Safedraw[®] Closed Arterial Sampling System

Disposable Transducer Sets
Sterile, single use

Safedraw arterial blood sampling systems are designed to reduce unnecessary blood discard and blood spillage. The system's self-sealing, silicone septum facilitates easier blood sampling for clinical testing.

DTXPLUS TRANSDUCER SETS WITH SAFEDRAW ARTERIAL SAMPLING

PRODUCT CODE	DESCRIPTION	LENGTH	TUBING COLOR	UNITS PER BOX/ CARTON
682142	DTXPlus 60' Disposable Pressure Monitoring Kit with Safedraw Blood Sampling System	120 / 30 cm	Clear	5/25
682143	DTXPlus 72" Disposable Pressure Monitoring Kit with Safedraw Blood Sampling System	150 / 30 cm	Clear	5/25

SAFEDRAW STAND-ALONE SETS

PRODUCT CODE	DESCRIPTION	LENGTH	TUBING COLOR	UNITS PER BOX/ CARTON
682144	Safedraw 60" Blood Sampling System	120/30 cm	Clear	5/50
682145	Safedraw 72" Blood Sampling System	150/30 cm	Clear	5/50

SAFEDRAW ACCESSORIES

PRODUCT CODE	DESCRIPTION	LENGTH	TUBING COLOR	UNITS PER BOX/ CARTON
682158	Safedraw BD Vacutainer [™] Transfer Device	N/A	N/A	25/125
682159	Safedraw Luer-Lok Safe-Needle	N/A	N/A	50/500

DISPOSABLE PRESSURE TRANSDUCER SETS

MeritTrans® Pressure Transducer Sets with Cardiac Catheterization Kit Configuration

MERITRANS® PRESSURE TRANSDUCERS

With reliable precision, customised configurations, and a clear fluid path, MeritTrans pressure transducers can be customized to fit the needs of your physicians and labs. Our transducers are available in both hand-held and Paley setups; MeritTrans can also be configured with a broad range of Merit accessories.

MERITRANS BLOOD PRESSURE TRANSDUCERS with winged housing. Packaged 25 units per box, 4 boxes per case.

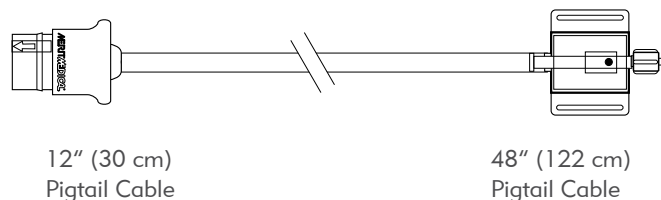

CATALOG NUMBER	MER100	MER148
-----------------------	--------	--------

MERITRANS BLOOD PRESSURE TRANSDUCER with non-winged housing. Packaged 25 units per box, 4 boxes per case.

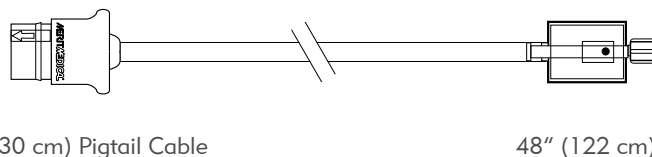

CATALOG NUMBER	MER212	MER200
-----------------------	--------	--------

MERITRANS MER100 with bonded standard pressure 1-way and 3-way Marquis® stopcocks. Packaged 25 kits per box, 4 boxes per case.

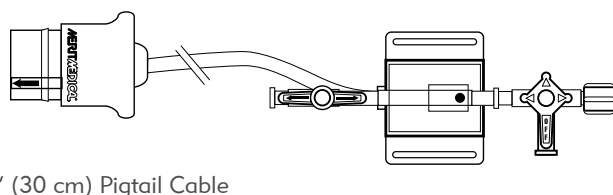

CATALOG NUMBER	K11-00096
-----------------------	-----------

MERITRANS MER100 with two bonded standard pressure 1-way Marquis stopcocks. Packaged 15 kits per box, 4 boxes per case.

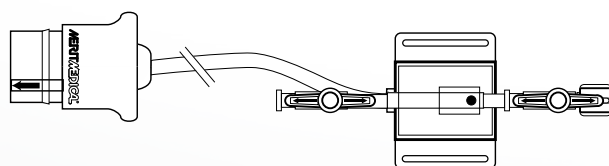

CATALOG NUMBER	K11-00098
-----------------------	-----------

Meritans[®] Pressure Transducers

MERITANS MER100 with two bonded standard pressure 3-way Marquis[®] stopcocks. Packaged 15 kits per box, 4 boxes per case.

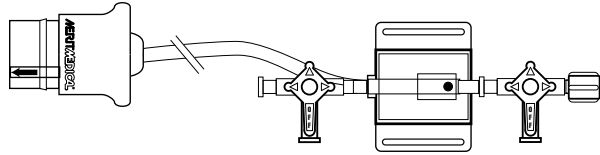

12" (30 cm) Pigtail Cable

CATALOG NUMBER K11-00099

MERITANS MER100 with bonded standard pressure 3-way and 1-way Marquis stopcocks. Packaged 15 kits per box, 4 boxes per case.

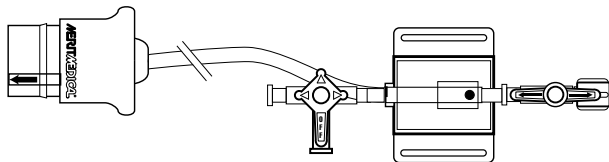

12" (30 cm) Pigtail Cable

CATALOG NUMBER K11-00100

MERITANS MER200 with bonded standard pressure 1-way Marquis stopcock. Packaged 25 kits per box, 4 boxes per case.

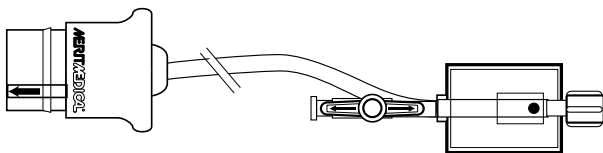

48" (122 cm) Pigtail Cable

CATALOG NUMBER K11-00137

MERITANS MER200 with a 3-way Marquis stopcock bonded to both ends. Packaged 15 kits per box, 4 boxes per case.

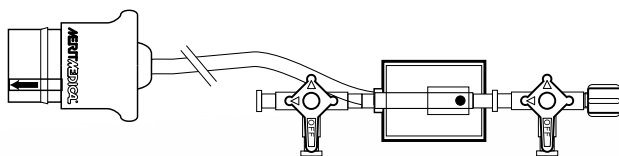

48" (122 cm) Pigtail Cable

CATALOG NUMBER K11-00144

DISPOSABLE PRESSURE TRANSDUCERS

Meritans[®] Pressure Transducers

MERITANS MER100 with 3-way Marquis[®] stopcocks bonded to the female luer, flush device and 72" (183 cm) small bore fluid administration line with vented/filtered drip chamber. Packaged 15 kits per box, 4 boxes per case.

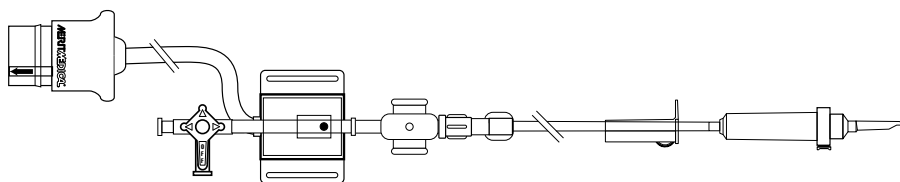

12" (30 cm) Pigtail Cable

CATALOG NUMBER K11-00280

MERITANS MER200 with a 3-way Marquis Stopcock (medium pressure, rotating male adapter) and a 1-way Marquis stopcock. Packaged 15 kits per box, 4 boxes per case.

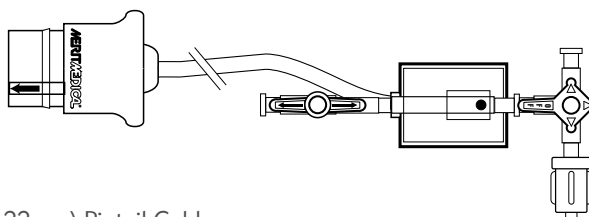

48" (122 cm) Pigtail Cable

CATALOG NUMBER K11-00392

MERITANS MER200 with a 3-way Marquis stopcock and a 1-way Marquis stopcock. Packaged 15 kits per box, 4 boxes per case.

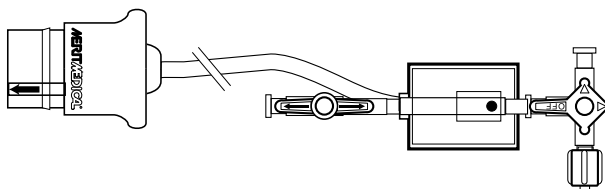

48" (122 cm) Pigtail Cable

CATALOG NUMBER K11-00202

MERITANS MER100 with a 1-way Marquis stopcock. Packaged 15 kits per box, 4 boxes per case.

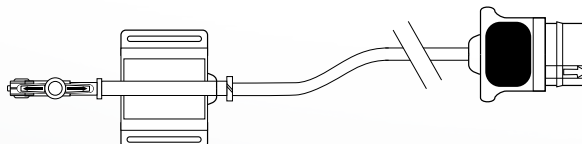

48" (122 cm) Pigtail Cable

CATALOG NUMBER K11-01321

Meritrans® Pressure Transducers

MERITRANS MER200 with a 3-way Marquis® Stopcock and a 1-way Marquis stopcock. Packaged 15 kits per box, 4 boxes per case.

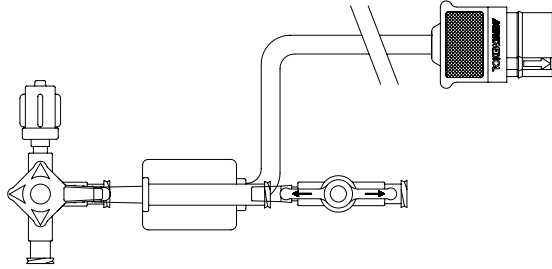

48" (122 cm) Pigtail Cable

CATALOG NUMBER K11-00419



DISPOSABLE PRESSURE TRANSDUCER SETS

TRAM[®] Manifolds with Integrated Transducer

The TRAM Manifold with Integral Transducer gives a single operator the convenience to de-bubble, zero and rezero within the sterile field. The TRAM has optimized clinician comfort by reducing hand fatigue with low torque, easy-to-turn wide-spaced handles, even when utilizing higher injection pressures. The Devos™ TRAM manifold has a check relief valve. Packaged 10 units per box, 4 boxes per case.

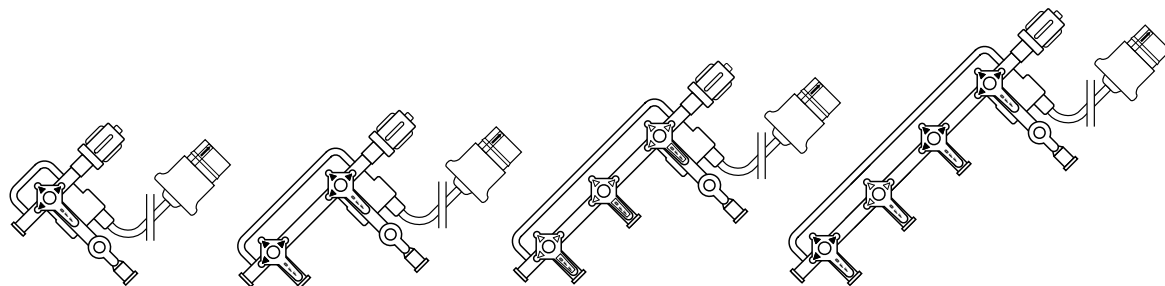

1 Port

2 Port

3 Port

4 Port

200 PSI (14 BAR)

ON Handles Wide				
Standard	201LTPHN-R		203LTPHN-R	
OFF Handles Wide		202LTPHWF-R	203LTPHWF-R	204LTPHWF-R
Devos				2V4LTPHWF-R
Devos with 360° handle				2V4LTPHWF-RT
Standard			203LTPHF-R	

500 PSI (34 BAR)

ON Handles Wide		502LTPHWN-R	503LTPHWN-R	504LTPHWN-R
Standard	501LTPHN-R		503LTPHN-R	
OFF Handles Wide		502LTPHWF-R	503LTPHWF-R	504LTPHWF-R
Standard			503LTPHF-R	

Tram-P™ Manifolds with Integral Transducer

The TRAM-P features a pressure transducer on the first port. By positioning the compensation line on an IV pole rather than on a table, the TRAM-P maintains a constant calibrated reading. With this configuration, the manifold can be moved to any position without affecting the accuracy of the pressure reading. Comfortable wide-spaced finger grip option. The Devos™ TRAM-P manifold has a check relief valve. Packaged 10 units per box, 4 boxes per case.

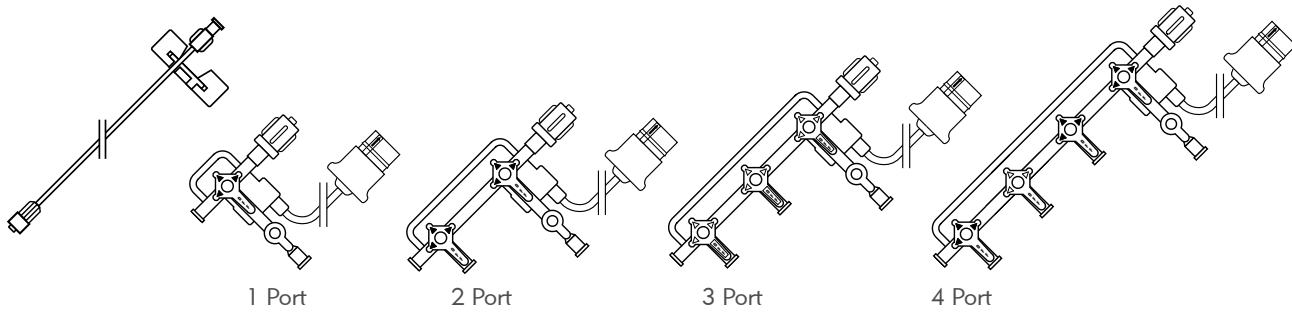

200 PSI (14 BAR)

ON Handles Wide		202LTCHWN-R	203LTCHWN-R	204LTCHWN-R
Standard	201LTCHN-R		203LTCHN-R	
OFF Handles Wide		202LTCHWF-R	203LTCHWF-R	204LTCHWF-R
Devos				22V4LTCHWF-R
Devos with 360° handle				2V4LTCHWF-RT
Standard			203LTCHF-R	

500 PSI (34 BAR)

ON Handles Wide		502LTCHWN-R	503LTCHWN-R	504LTCHWN-R
Standard	501LTCHN-R		503LTCHN-R	
OFF Handles Wide		502LTCHWF-R	503LTCHWF-R	504LTCHWF-R
Standard	501LTCHF-R		503LTCHF-R	



TRAM-P™
Transducer and Manifold

DISPOSABLE PRESSURE TRANSDUCERS AND TRANSDUCER SETS

ArgoTrans™

Disposable Transducers and Transducer Sets

Sterile, single use

The ArgoTrans transducer features a straight flow-through fluid path. With the Universal Steriflo™ flush device, ArgoTrans transducers give you the flexibility to flush the system as you choose—gently pull the tab or squeeze the side wings.

ARGOTRANS TRANSDUCERS

PRODUCT CODE	DESCRIPTION	CABLE LENGTH	STOPCOCK	UNITS PER BOX
041596505A	ArgoTrans with integral 4-way Stopcock and Flush Device	14" (35cm)	4-Way	20
041588505A	Neonatal Disposable Transducer Kit with 30mL/hr Flush Device and Double 4-Way Stopcocks for Continuous Monitoring	36" (91cm)	4-Way	10
041582505A	Patient Mount Disposable Transducer Kit with 3mL/hr Flush Device and 4-Way Stopcocks for Continuous Monitoring	9" (23cm)	4-Way	10
041589507A	ArgoTrans with 4-way & 1-Way Stopcocks	14" (35cm)	1-Way & 4-Way	20
041516504A	ArgoTrans with Male/Female Luers	14" (35cm)		20
041517504A	ArgoTrans with 1-way Stopcock	42" (107cm)	1-Way	20
041587505A	ArgoTrans with 1-way Stopcock	60" (152cm)	1-Way	20
041516503A	M/F Transducer 42" Cable	W/ 1 way stopcock		

PRODUCT CODE	DESCRIPTION	PRIMARY TUBING LENGTH	PRIMARY TUBING LENGTH
041584555A	ArgoTrans Transducer set	Trans 3ml flush micro	4' Line 9" extrn stopcock

ARGOTRANS TRANSDUCER KITS

PRODUCT CODE	DESCRIPTION	PRIMARY TUBING LENGTH	ARTERIAL EXTENSION TUBING LENGTH	DRIP CHAMBER	UNITS PER BOX
041591505A	Triple Pressure Disposable Transducer Kits with Trifurcated Drip Chamber, 3mL/hr Flush Device and 4-way Stopcocks for Continuous Monitoring (Color coded tubing 72" Red, 48" Blue & 48" Yellow)	72" (183cm)	12" (30cm)	Macro-Drip	10
041585505A	Single Pressure Disposable Transducer Kits with Drip Chamber, 3mL/hr Flush Device and 4-way Stopcocks for Continuous Monitoring	72" (183cm)	9" (23cm)	Macro-Drip	10
041584505A	Single Pressure Disposable Transducer Kits with Drip Chamber, 3mL/hr Flush Device and 4-way Stopcocks for Continuous Monitoring	48" (122cm)	9" (23cm)	Macro-Drip	10
041586505A	Single Pressure Disposable Transducer Kits with Drip Chamber, 3mL/hr Flush Device and 4-way Stopcocks for Continuous Monitoring	72" (183cm)	9" (23cm)	Macro-Drip	10
041589505A	Double Pressure Disposable Transducer Kits with Bifurcated Drip Chamber, Two 3mL/hr Flush Device and 4-way Stopcocks for Continuous Monitoring	72" (183cm)	12" (30cm)	Macro-Drip	10
041583505A	Single Pressure Disposable Transducer Kits with Drip Chamber, 3mL/hr Flush Device and 4-way Stopcocks for Continuous Monitoring	48" (122cm)	9" (23cm)	Macro-Drip	10

ArgoTrans™ KeepSafe™

Closed Sampling Transducer Kits

Sterile, single use

Blood-borne pathogen exposure is costly and life-threatening to critical care patients. The KeepSafe closed sampling system minimizes patient risk and allows clinicians to conveniently and safely retrieve patient blood samples without exposing the patient to the ambient environment.

PRODUCT CODE	DESCRIPTION	PRIMARY TUBING LENGTH	ARTERIAL EXTENSION TUBING LENGTH	DRIP CHAMBER	SAMPLING STOPCOCKS	UNITS PER BOX
041592505A	KeepSafe Closed Sampling Transducer Kit with Drip Chamber, 3mL/hr Flush Device, Covered Reservoir Syringe, Sampling Stopcock, Arterial extension and 4-way stopcocks	48" (122cm)	9" (23cm)	Macro-Drip	1	10
041593505A	KeepSafe Closed Sampling Transducer Kit with Drip Chamber, 3mL/hr Flush Device, Covered Reservoir Syringe, Sampling Stopcock, Arterial extension and 4-way stopcocks	72" (183cm)	9" (23cm)	Macro-Drip	1	10
041594505A	Triple Pressure KeepSafe Closed Sampling Kits with Trifurcated Drip Chamber, Three 3mL/hr Flush Device and 4-way Stopcocks for Continuous Monitoring	72" (183cm)	12" (30cm)	Macro-Drip	1	10
041597505A	Triple KeepSafe Closed Sampling Kit for Anesthesia	48" (122cm)	9" (23cm)	Macro-Drip	2	10

ACCESSORIES



DTXPlus® Accessories

Sterile, single use

PRODUCT CODE	MALE/FEMALE OR MALE/MALE LINE CONNECTION	TUBING LENGTH	LINE COLOR CODING	BOX/CASE CONTENT (UNITS)	PRIMING VOLUME (CM ³ /CM)	TUBE DIAMETER INNER (MM)	OUTER (MM)
--------------	------------------------------------------	---------------	-------------------	--------------------------	--------------------------------------	--------------------------	------------

PRESSURE LINES (PVC)

682229	M/F	100cm	Clear	25/125	0.019	1.575 (± 0.076)	3.175 (± 0.051)
682230	M/F	150cm	Clear	25/125	0.019	1.575 (± 0.076)	3.175 (± 0.051)
682232	M/F	200cm	Clear	25/125	0.019	1.575 (± 0.076)	3.175 (± 0.051)
682234	M/M	100cm	Clear	25/125	0.019	1.575 (± 0.076)	3.175 (± 0.051)
682079	M/M	150cm	Clear	25/125	0.019	1.575 (± 0.076)	3.175 (± 0.051)
682236	M/M	200cm	Clear	25/125	0.019	1.575 (± 0.076)	3.175 (± 0.051)
682237	M/F	100cm	Red	25/125	0.019	1.575 (± 0.076)	3.175 (± 0.051)

CONNECTA PE PRESSURE MONITORING LINES (POLYETHYLENE)

682194	M/F	15cm	Clear (Red/Blue Stickers)	25/250	0.011	1.20 (± 0.05)	2.50 (+ 0.1/- 0.05)
682185	M/F	50cm	Clear (Red/Blue Stickers)	25/250	0.011	1.20 (± 0.05)	2.50 (+ 0.1/- 0.05)
682189	M/F	100cm	Clear (Red/Blue Stickers)	25/250	0.011	1.20 (± 0.05)	2.50 (+ 0.1/- 0.05)
682191	M/F	150cm	Clear (Red/Blue Stickers)	25/250	0.011	1.20 (± 0.05)	2.50 (+ 0.1/- 0.05)
682192	M/F	200cm	Clear (Red/Blue Stickers)	25/250	0.011	1.20 (± 0.05)	2.50 (+ 0.1/- 0.05)
682186	M/M	50cm	Clear (Red/Blue Stickers)	25/250	0.011	1.20 (± 0.05)	2.50 (+ 0.1/- 0.05)
682190	M/M	100cm	Clear (Red/Blue Stickers)	25/250	0.011	1.20 (± 0.05)	2.50 (+ 0.1/- 0.05)
682193	M/M	200cm	Clear (Red/Blue Stickers)	25/250	0.011	1.20 (± 0.05)	2.50 (+ 0.1/- 0.05)

R.O.S.E (RESONANCE OVER-SHOOT ELIMINATOR)

PRODUCT CODE	DESCRIPTION	LENGTH	TUBING COLOR	UNITS PER BOX
682105	R.O.S.E (Resonance Over-Shoot Eliminator)	N/A	N/A	25/250

PRESSURE ACCESSORIES (NON-STERILE)

PRODUCT CODE	MODEL	DESCRIPTION	BOX/CASE CONTENT (UNITS)
682093	TBG	Transducer BackGround for pole mounting (up to 4 transducers)	10/100
682274	TMM	Snap-On TMM Cable Organiser	5/50
682275	TMM/TBG	TBG with Snap-On TMM Cable Organiser (P/Ns 682093, 682274)	5/50
684003	Cable Checker	Transducer tester for monitor calibration	1
682104	UMM	Universal Manifold Mount	5/50



Interface Cables for DTXPlus® Transducers

Merit supplies compatible interface cables for the majority of currently available blood pressure monitors.

Below are the most common interface cables for use with Merit's DTXPlus transducers. If your requirements are not listed, please contact your local Merit office for assistance.

When purchasing cables, please specify:

1. Monitor type.
2. Model number and/or serial number.

PRODUCT CODE	MONITOR	MODEL
684109	No Monitor Connection	(Flying Leads) Shield: Dependent on Monitor. Black: + Signal; White: - Signal. Green: + Excitation; Red: - Excitation
684085	Criticon / GE Marquette	Dynamap
684078	Datascope / Mindray	All Models (Passport, Accutorr, CS100/CS300 IABP)
684128	Dräger	PM8040, PM8060, Dräger Cato, Cicero & Julian Anes. Machine, Vitaro
684082	Dräger / Siemens	400 Series, 960, 961, Sirecusc 4041, 700, 1260, 342, 732, SC7000, SC8000), SC9000), Infinity Gamma, Infinity Delta, Infinity Kappa, Infinity Vista all with 10 pin connector
684236	Dräger / Siemens	Hemo Pod Adapter (One adapter for each Hemo2 Pod and two for each Hemo4/HemoMed Pod)
684128	E for M	RM300 (E for M/Honeywell)
684104	GE / Datex Ohmeda	GE Monitor with Datex-Ohmeda 'front end': SYS 800, MOD 8641, SIVA 3000, Cardiocap, Cardiocap II, AS3, S5, Aestiva, ADU(S5) and Aisys
684102	GE / Marquette	GE Monitor with Marquette 'front end': 7009 / Tramscope Series(600SL) - Eagle-Solar 8000, Solar 9000, Eagle3000/1000, Mab Lab 6Fx3F, Tram 450SL, 6200, Tram600A, EK36, Dash 3000, Dash 4000, Dash 5000
684138	Jostra	
684129	Kontron, Arrow	Minimon 7131 etc., 7132 etc., K2000, 7272 / Supermon 7210 / Cart 2 Plus Balloon Pump, Oxford ACAT1
684096	Marquette (GE)	7000 Series, 7010 Mod 7200
684085	Mindray	PM8000, PM7000, PM9000, Spectrum; MEC Series; Passport/Spectrum
684081	Mindray	BeneView T5, T8, T1; IPM (8, 10, 12); BeneHeart D6
684085	Nellcor	Escort 300 MDE
684090	Nihon Kohden	MFV1100,1200,1230A; Lifescope 8, 9, 11, 12, 14,BSM-8300J/K, 3000, BSM4100
684081	Philips	78341A, 78342A, etc. / 78354C, 78205A-D, 12-pin / 78352, CMS (Merlin line), M1006A/B, M1026A / M1166A / Viridia / HP Scop Eurelie 24C, CMS2001, V24, V26, M2, M3, M4, Intelivue
684230	Physiocontrol/Medtronic	Lifepack 12 (6 pin)
684085	Protocol Propaq	Protocol Propaq series; Propaq 106EL
684181	Prucka Eng. Inc.	Cardiolab II / 1.1, AMP II
684085	Spacelabs	Series 400, 500, 90308/11/31, MOD-CD
684227	Spacelabs (Vitatek) / BCI	400, 500, 90485, Alpha-PC, 90603A, BCI 9100, 90303B-Mod90470-05, CD-CV, 90369, 90385, 90470, 90496, Ultraview 1600
684188	Stöckert (Sorin)	S3 / S5
684243	Stöckert (Sorin)	Heart Lung Machine
684085	Tektronics	400 Series
684085	Vitalert	2000
684085	Vitatek	Series 400, 500
684085	Welch Allyn	1500
684085	Zoll	Zoll Defibrillators

ACCESSORIES



No Monitor Connection ('flying lead')
 Wiring Guide:
 (+) Excitation Voltage
 (-) Excitation Voltage
 (+) Signal
 (-) Signal
 Dependant on monitor specification



Criticon/GE Marquette – Dynamap
Mindray - PM/MEC Series, Spectrum
Nellcor - Escort 300 MDE
Physiocontrol (Medtronic) - Lifepack12
Protocol Propaq - Protocol Propaq series; Propaq 106EL;
Spacelabs - Series 400, 500, 90308/11/31,
 MOD-CD, CD-CV Tektronics - 400 Series
Vitalert – 2000
Vitatek - Series 400, 500
Welch Allyn - 1500
Zoll - Zoll Defibrillators



Datascope/Mindray – All Models
 Passport, Accutorr, CS100/CS300 IABP



E for M/Honeywell
 RM300
Dräger
 PM8040, PM8060, Dräger Vitarä, Cato, Cicero &
 Julian Anes. machine,
Philips
 CM140



Dräger/Siemens
 400 Series, 960, 961, Sirecust 4041,700,1260, 342,
 732, Sirecust 342, 4XX, 7XX, 9XX, 12XX
 SC7000, SC8000, SC9000, Infinity Gamma, Delta,
 Kappa, Vista all with 10 pin connector



Dräger/Siemens
 SC6000P, 6002, 5000, 6004, 7000, Infinity Gamma,
 Delta, Kappa, Vista all with 7 pin connector



684236 – 15 Pin M

Dräger/Siemens

Hemo Pod Adapter (One adapter for each Hemo2 Pod & two for each Hemo4/HemoMed Pod)



684104 / 684271 – 10 Pin F - LF

GE / Datex-Ohmeda

GE Monitor with Datex-Ohmeda 'front end':
SYS 800, MOD 8641, SIVA 3000, Cardiocap,
Cardiocap II, AS3, S5, Aestiva, ADU(S5) and Aisys



684102 / 684270 - 11 Pin M - LF

GE / Marquette

GE Monitor with Marquette 'front end':
7009 / Tramscope Series(600SL), Eagle-Solar 8000,
9000, 3000/1000, Mab Lab 6Fx3F, Tram 450SL, 6200,
Tram600A, EK36, Dash 3000, Dash 4000, Dash 5000,
Carescape B650



684138 – 5 Pin M

Jostra

(Heart pump)



684129 / 684278 – 12 Pin M - LF

Kontron, Arrow

Minimon 7131, 7132 etc, K2000, 7272 / Supermon 7210
/ Cart 2 Plus, Balloon Pump, Oxford ACAT1



684096 – 8 Pin M - LF

GE / Marquette

7000 series, 7010, Mod 7200



684090 / 684277 – 5 Pin M - LF

Nihon Kohden

MFV1100, 1200, 1230A; Lifescope 8, 9, 11, 12, 14,
BSM-8300J/K, 3000, BSM4100



JP - 900P (OTCN KB559)

Nihon Kohden

NK9000

ACCESSORIES



Philips

CMS (Merlin line), M1006A/B, M1026A / M1166A / Viridia / HP Scop Eurelie 24C, CMS2001, V24, V26, M2, M3, M4, Intelivue

Mindray

BeneView T5, T8, T1; IPM (8, 10, 12); BeneHeart D6



Prucka Eng Inc.

CARDIOLAB II / 1.1, AMP II



Spacelabs (Vitatek)

BCI - 400, 500, 90485, Alpha-PC, 90603A, BCI 9100, 90303B-Mod90470-05, CD-CV, 90369, 90385, 90470, 90496, Ultraview 1600



Stöckert (Sorin)

S3, S5



Stöckert (Sorin)

Heart Lung Machine



684056 Model: SP4042

In-Line Injectate Sensor Cable

For use with Abbott Oximetrix, Arrow, Baxter, Edwards 9520A or Com1, Mennen Horizon 2000 series (Cable 800-030-200), Spacelebs Alpha PC or PCMS (bifurcated cable model 306655-001), Datex AS3 and Critikit Injectate Set or SP5045 Sensor Housing



684062 Model: SP4045

In-Line Injectate Sensor Cable

For use with Nihon Kohden, Spacelabs (bifurcated cable model 306655-002), Fukuda Denshi IB5006 (DSCP), Dynascope DS3300 and Critikit Injectate Set or SP5045 Sensor Housing



684057 Model: SP4043

In-Line Injectate Sensor Cable

For use with Siemens bifurcated cable, Siemens Pod system (model 8419145) and Critikit Injectate Set or SP5045 Sensor Housing



684063 Model: SP4046

In-Line Injectate Sensor Cable

For use with Philips Cardiac Output module (trifurcated cable M1641A or M1642A) and Critikit Injectate Set or SP5045 Sensor Housing

ACCESSORIES

Meritrans® Accessories

MERITRANS® ORGANIZER

Plate with colored labels. Packaged 5 units per box.

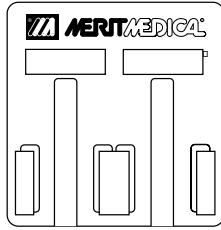

2 Port

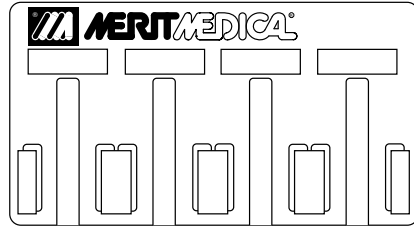

4 Port

CATALOG NUMBER

MER110

MER111

CLIPPER POLE MOUNT

Packaged 1 unit per box.

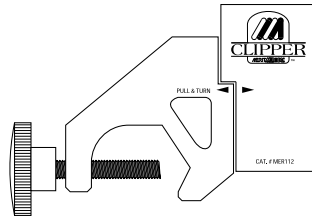

Rotates to Vertical or Horizontal Position

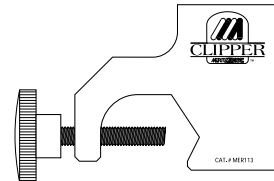

Fixed Position

CATALOG NUMBER

MER112

MER113

NOTE: Autoclavable Clipper® (MER113A) is available upon special request. Please allow six weeks lead time for delivery.

MERITRANS REUSABLE CABLE SERIES

Includes 19 standard cables for use with most monitor configurations. Compatible cables for your monitoring system available through your Merit representative.

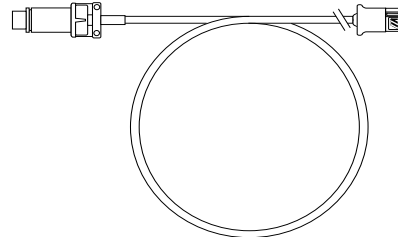

The Mentor™ Pressure Transducer Simulator/Tester

Accuracy:

$\pm 1\%$ of Reading or ± 1 mmHg, whichever is greater

Sensor Overpressure:

1000mmHg

Mentor Working Pressure Range:

+300 mmHg, displays "OPr" when outside this range

Transducer Simulator:

- Sensitivity: $5 \mu\text{V/V/mmHg}$, $\pm 1\%$
- Excitation: 2 to 10 vdc, or vac rms to 5 khz
- Input Impedance: 2300Ω , 330Ω with Reusable Cable
- Output Impedance: 300Ω
- Asymmetry: Less than 1%

Electronic, hand-held simulator to help you troubleshoot your Hemodynamic system

MER500

With 0.2 Micron Microbiological Filter

MER555



ACCESSORIES

Meritrans Cables

MERITRANS REUSABLE CABLE SERIES

Includes 19 standard cables for use with most monitor configurations. Compatible cables for your monitoring system available through your Merit representative.

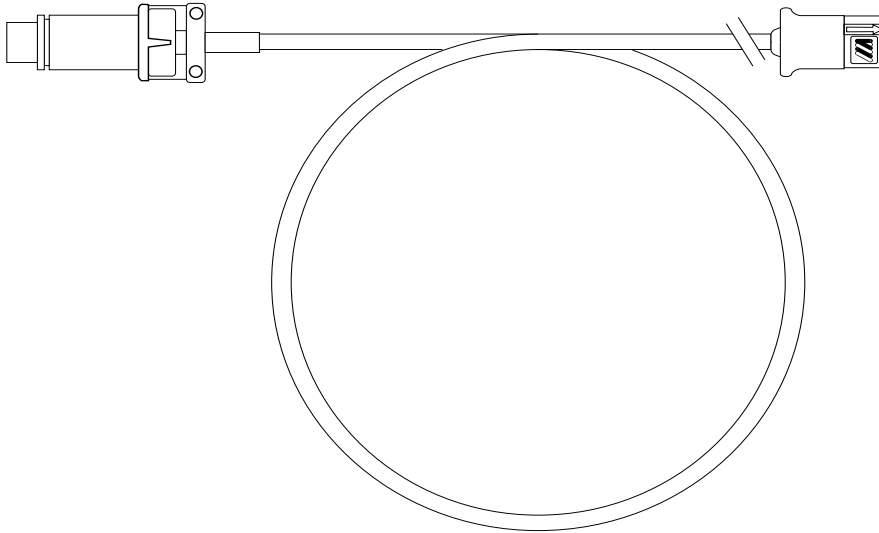

ArgoTrans™ Pressure Transducer Accessories

Sterile, single use

STOPCOCKS AND FLUSH DEVICES

PRODUCT CODE	DESCRIPTION	UNITS PER BOX
041300003A	3mL Flush Device (Male port Out)	25
041300013A	3mL Flush Device (Male and Female ports Out)	25

MONITORING ACCESSORIES

PRODUCT CODE	DESCRIPTION	UNITS PER BOX
041520000A	3-Position Half-Moon Bracket And Plastic Manifold Holder (Non-Sterile)	1
041520100A	4-Position Half-Moon Bracket And Plastic Manifold Holder (Non-Sterile)	1
041519000A	Manifold Holder, Plastic (Non-Sterile)	1

INTERFACE CABLES

PRODUCT CODE	DESCRIPTION	REUSABLE	QUANTITY	INTERFACE
041746012	Cable, transducer	Reusable	1 EA	GE / Marquette 11 pin

MISCELLANEOUS

PRODUCT CODE	DESCRIPTION
041530500A	Patient mount strap



THERMODILUTION & PULMONARY ARTERY CATHETERS

29 Exacta® Percutaneous Sheath Introducer Sets

30 Critikit™ Cardiac Output Injectate Kits and Accessories

31 Pulmonary Artery Catheters

31 Thermodilution Catheters

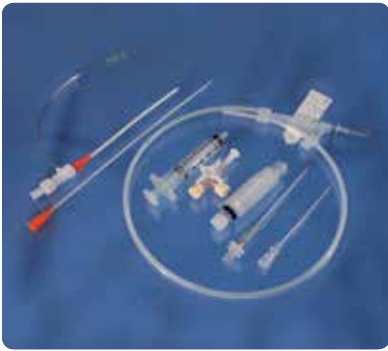

Exacta® Percutaneous Sheath Introducer Sets

Sterile, single use

PERCUTANEOUS SHEATH INTRODUCERS FOR THE INTRODUCTION OF PULMONARY ARTERY CATHETERS

PRODUCT CODE	SIZE*	INTRODUCER LENGTH	CANNULA INTRODUCER		NEEDLE INTRODUCER		GUIDEWIRE OD & LENGTH	CONTAMINATION SHIELD LENGTH	HIGH-FLOW STOPCOCK	SYRINGE	SCALPEL	OBTURATOR	BOX/CASE CONTENT (UNITS)
			GAUGE	LENGTH	GAUGE	LENGTH							
680128	6Fr	10 cm	16G	7 cm	17G	7 cm	0.9 x 45 cm	80 cm	Yes	Yes	Yes	Yes	5/50
680140	7Fr	10 cm	16G	7 cm	17G	7 cm	0.9 x 45 cm	80 cm	Yes	Yes	Yes	Yes	5/50
680126	8Fr	10 cm	16G	7 cm	17G	7 cm	0.9 x 45 cm	80 cm	Yes	Yes	Yes	Yes	5/50
680132	Link Kit 8.5Fr	10 cm	16G	7 cm	17G	7 cm	0.9 x 45 cm	-	Yes	Yes	Yes	Yes	5/50
680124	8.5Fr	10 cm	16G	7 cm	17G	7 cm	0.9 x 45 cm	80 cm	Yes	Yes	Yes	Yes	5/50

* For introduction of 1Fr smaller size catheters

PRODUCT DESCRIPTION

- Radiopaque FEP sheath with integral sidearm
- Tuohy Borst adapter and hemostasis valve
- Matched dilator with luer lock collar
- Exacta® sets include a contamination shield with Tuohy Borst lock
- Two separately packaged sterile obturators supplied per box of 5 Exacta® sheath systems

How Merit percutaneous introducers can benefit you

- Radiopaque FEP sheath is designed to reduce the risk of thrombus
- Flexible hub minimizes potential for kinking of introducers
- Suture point facilitates skin fixation
- Profiled sheath tip and matched dilator is designed to facilitate a smooth atraumatic insertion
- Dilator luer locking collar secures dilator to sheath hub during insertion
- Latex free, self-sealing hemostasis valve is designed to minimise the risk of blood loss
- Exacta® sets include the Venaguide™ Seldinger wire-advancing device, which allows single-handed wire insertion



Critikit™ Ice/Room Temperature Injectate Systems and Accessories

Sterile, single use

CLOSED LOOP IN-LINE INJECTATE SYSTEMS FOR IMPROVED ACCURACY OF CARDIAC OUTPUT MEASUREMENT

PRODUCT CODE	DESCRIPTION	STERILE	BOX/CASE CONTENT (UNITS)
680000	Ice/Room temperature Injectate Critikit (with in-line sensor, control syringe & cooling coil)	Yes	4/8
680002	Injectate delivery system for performing cardiac output measurements.	Yes	5
680006	In-line injectate sensor housing	Yes	25/250
682252	10 mL control syringe	Yes	10/50

PRODUCT DESCRIPTION

- Available in both iced and room temperature injectate options
- Closed circuit design offers an aseptic approach to cardiac output measurement
- Set comprises an injectate sensor housing with three-way stopcock, one-way check valve, 10cc syringe, cooling coil, delivery tubing and IV spike

How Critikit™ can benefit you

- Closed loop system is designed to reduce the risk of line contamination
- Insulated volume-restricted syringe facilitates precise and reproducible injectate
- In-line injectate sensor optimises accuracy of temperature readings
- Syringe design allows smooth injectate action improving data validity

NON-STERILE ACCESSORIES

PRODUCT CODE	DESCRIPTION	STERILE	BOX/CASE CONTENT (UNITS)
684056	In-line injectate sensor cable. For use with Abbott Oximetrix, Arrow, Baxter Edwards 9520A or Com1, Mennen Horizon 2000 Series (cable 800-030-200), Spacelabs Alpha PC or PCMS (bifurcated cable model 306655-001), Datex AS3 and Critikit Injectate set or SP5045 sensor housing.	No	1
684057	In-line injectate sensor cable. For use with Siemens bifurcated cable, Siemens Pod system (Model 8419145) and Critikit Injectate® set or SP5045 sensor housing.	No	1
684062	In-line injectate sensor cable. For use with HemoPro (SP1445), Nikon Kohden, Spacelabs (bifurcated cable model 306655-002), Fukuda Denshi IB5006 (DSCP), Dynascope DS3300 and Critikit Injectate set or SP5045 sensor housing.	No	1
684063	In-line injectate sensor cable. For use with Hewlett Packard Cardiac Output Module (HP trifurcated cable M1641A or M1642A) and Critikit Injectate set or SP5045 sensor housing.	No	1

Pulmonary Artery Catheters

Sterile, single use

PULMONARY ARTERY CATHETERS (HEPARIN COATED WITH LATEX BALLOON)

PRODUCT CODE	FRENCH SIZE	LUMEN	LENGTH	GUIDE WIRE	UNITS PER BOX
497527	6F	2	110cm	Accepts .018" Wire	5
497523	7F	2	110cm	Accepts .025" Wire	5
497540	7F	2	110cm	Accepts .035" Wire	5

Thermodilution Catheters

Sterile, single use

THERMODILUTION CATHETERS - STANDARD (HEPARIN COATED WITH LATEX BALLOON)

PRODUCT CODE	FRENCH SIZE	LUMEN	LENGTH	GUIDE WIRE	SPECIAL FEATURE	UNITS PER BOX
497537	6F	4	110cm	Accepts .018" Wire	Safety Wedge/Sleeve	5
497521	7F	4	110cm	Accepts .025" Wire	Safety Wedge/Sleeve	5
497539	7F	4	110cm	Accepts .025" Wire	Safety Wedge	5
497526	7F	4	110cm	Accepts .025" Wire		5
497520	7.5F	5	110cm	Accepts .025" Wire	Safety Wedge/Sleeve	

THERMODILUTION CATHETERS - S-CURVE TIP (HEPARIN COATED WITH LATEX BALLOON)

PRODUCT CODE	FRENCH SIZE	LUMEN	LENGTH	GUIDE WIRE	SPECIAL FEATURE	UNITS PER BOX
497534	6F	4	110cm	Accepts .025" Wire	Safety Wedge/Sleeve	5
497536	7F	4	110cm	Accepts .025" Wire		5

THERMODILUTION CATHETERS - SOFT BODY (HEPARIN COATED WITH LATEX BALLOON)

PRODUCT CODE	FRENCH SIZE	LUMEN	LENGTH	GUIDE WIRE	SPECIAL FEATURE	UNITS PER BOX
497531	7.5F	5	110cm	Accepts .025" Wire	Safety Wedge/Sleeve	5



CENTRAL VENOUS CATHETERS

33 Secalon-T™ Emergency Catheters

34 Careflow™ Central Venous Catheters and Catheter Sets



Secalon-T™

Sterile, single use

- Secalon-T emergency catheter designed for high flow rate infusions.
- PTFE (Polytetrafluoroethylene) material construction and incorporating a Floswitch®, Secalon-T is ideal for rapid short-term insertion into central veins or large peripheral vessels.
- Complete kit contains pre-puncture stylus and stabilizing wing.

ORDERING INFORMATION

PRODUCT CODE	GAUGE	LENGTH	CATHETER EXTERNAL DIAMETER	COLOUR	BOX/CASE CONTENT (UNITS)	FLOW RATE (ML/MIN)
681000	18G	90mm	1.2mm	Green	25/250	55
681002	16G	130mm	1.7mm	Grey	25/250	139
681004	16G	160mm	1.7mm	Grey	25/250	128
681006	14G	160mm	2.0mm	Orange	25/250	206



Careflow™ Central Venous Catheters

Single Lumen without Extension

Sterile, single use

- Careflow is a central venous catheter designed for catheterization via the Seldinger technique.
- Range of sets contains a Nitinol guidewire and the Venaguide™ Seldinger wire-advancing device facilitating single-handed guidewire insertion.
- Tapered atraumatic catheter tip designed to reduce the risk of venous damage while improving catheter insertion.
- The streamlined junction hub enables ease of catheter suture and comfortable positioning on the patient's skin.
- Careflow catheters offer 1cm and 5cm interval depth markings to facilitate catheter placement and clear lumen size and hub color coding indication.
- Floswitch® and Floswitch® Introducer Catheter options available throughout range.
- Pressure rated with a maximum pressure tolerance of 45 psi.

CAREFLOW™ SINGLE LUMEN SETS WITHOUT EXTENSION

CODE WITHOUT FLOSWITCH	CODE WITH FLO-SWITCH	EXTERNAL DIAMETER	LENGTH	CANNULA INTRODUCER		FLOSWITCH® INTRODUCER		NEEDLE INTRODUCER		GUIDEWIRE OD & LENGTH	SECONDARY FIXATION (SFD)	BOX/CASE CONTENT (UNITS)	FLOW RATE (ML/MIN)
				GAUGE	LENGTH	GAUGE	LENGTH	GAUGE	LENGTH				
681614	681623	2.5Fr (22G)	10 cm	N/A	N/A	20G	4.5 cm	22G	4 cm	0.5 x 35 cm		10/100	10
681639	681640 [≠]	3Fr (20G)	15 cm	N/A	N/A	20G	4.5 cm	22G	4 cm	0.5 x 35 cm		10/100	16
681643	681644	3Fr (20G)	20 cm	N/A	N/A	20G	4.5 cm	22G	4 cm	0.5 x 45 cm		10/100	15
681649	681650	4Fr (18G)	20 cm	N/A	N/A	18G	6 cm	17G	7 cm	0.6 x 45 cm		10/100	36
681669	681670	5Fr (16G)	15 cm	N/A	N/A	15G	7 cm	17G	7 cm	0.9 x 45 cm	Yes	10/100	71
681672	681673	5Fr (16G)	20 cm	N/A	N/A	15G	7 cm	17G	7 cm	0.9 x 45 cm	Yes	10/100	63
681706	681707	7Fr (14G)	15 cm	N/A	N/A	14G	7 cm	17G	7 cm	0.9 x 45 cm	Yes	10/100	190
681709	681710	7Fr (14G)	20 cm	N/A	N/A	14G	7 cm	17G	7 cm	0.9 x 45 cm	Yes	10/100	136

PRODUCT CONTENTS

Single lumen Careflow with Floswitch set contents:

Careflow Polyurethane catheter, steel needle introducer, Floswitch overneedle introducer, vessel dilator, Venaguide Seldinger wire-advancing device with Nitinol guidewire, Floswitch revolving Luer-Lok™ system, luer lock plug and secondary fixation device (where shown).

Single lumen Careflow without Floswitch set contents:

Careflow Polyurethane catheter, steel needle introducer, vessel dilator, Venaguide Seldinger wire-advancing device with Nitinol guidewire and secondary fixation device (where shown).

[≠] Note: Part number 681640 contains 0.5 x 450mm guidewire.

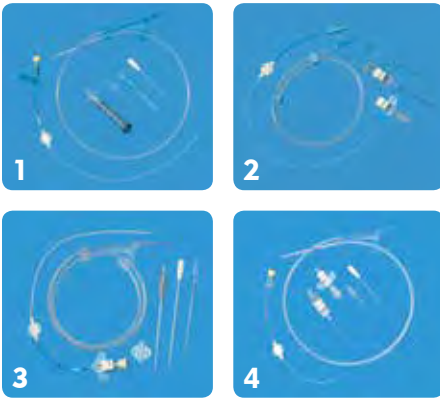

Careflow™ Central Venous Catheter Sets

Single Lumen
Sterile, single use

CODE WITHOUT FLOSWITCH*	CODE WITH FLOSWITCH*	EXTERNAL DIAMETER	LENGTH	CANNULA INTRODUCER		FLOSWITCH* INTRODUCER		NEEDLE INTRODUCER		GUIDEWIRE OD & LENGTH	SECONDARY FIXATION (SFD)	BOX/CASE CONTENT (UNITS)	FLOW RATE (ML/MIN)
				GAUGE	LENGTH	GAUGE	LENGTH	GAUGE	LENGTH				

1. CAREFLOW™ SINGLE LUMEN SETS WITH EXTENSION

681612		2.5Fr (22G)	6 cm	22G	3.8 cm	N/A	N/A	22G	4 cm	0.5 x 35 cm		5/50	12
681622		2.5Fr (22G)	10 cm	22G	3.8 cm	N/A	N/A	22G	4 cm	0.5 x 35 cm		5/50	10
681634		2.5Fr (22G)	20 cm	22G	3.8 cm	N/A	N/A	22G	4 cm	0.5 x 65 cm		5/50	7
681647		3Fr (20G)	15 cm	20G	4.5 cm	N/A	N/A	22G	4 cm	0.5 x 45 cm		5/50	18
681638		3Fr (20G)	20 cm	20G	4.5 cm	N/A	N/A	22G	4 cm	0.5 x 65 cm		5/50	15
681624		4Fr (18G)	6 cm	20G	4.5 cm	N/A	N/A	22G	4 cm	0.5 x 35 cm		5/50	47
681658		4Fr (18G)	20 cm	20G	4.5 cm	N/A	N/A	22G	4 cm	0.5 x 65 cm		5/50	35
681662		5Fr (16G)	15 cm	16G	7 cm	N/A	N/A	17G	7 cm	0.9 x 45 cm	Yes	5/50	65
681666		5Fr (16G)	20 cm	16G	7 cm	N/A	N/A	17G	7 cm	0.9 x 70 cm	Yes	5/50	60
681679		5Fr (16G)	30 cm	16G	7 cm	N/A	N/A	17G	7 cm	0.9 x 70 cm	Yes	5/50	46
681698		7Fr (14G)	15 cm	16G	7 cm	N/A	N/A	17G	7 cm	0.9 x 45 cm	Yes	5/50	159
681699		7Fr (14G)	20 cm	16G	7 cm	N/A	N/A	17G	7 cm	0.9 x 70 cm	Yes	5/50	149
681701		7Fr (14G)	30 cm	16G	7 cm	N/A	N/A	17G	7 cm	0.9 x 70 cm	Yes	5/50	136

2. CAREFLOW™ SINGLE LUMEN SET WITH FLOSWITCH*

	681633	2.5Fr (22G)	20 cm	N/A	N/A	20G	4.5 cm	22G	4 cm	0.5 x 45 cm		10/100	7
--	--------	-------------	-------	-----	-----	-----	--------	-----	------	-------------	--	--------	---

3. CAREFLOW™ SINGLE LUMEN WITH INTEGRAL FLOSWITCH*

	681660	5Fr (16G)	15 cm	N/A	N/A	15G	7 cm	17G	7 cm	0.9 x 45 cm	Yes	10/100	65
	681664	5Fr (16G)	20 cm	N/A	N/A	15G	7 cm	17G	7 cm	0.9 x 70 cm	Yes	10/100	60
	681678	5Fr (16G)	30 cm	N/A	N/A	15G	7 cm	17G	7 cm	0.9 x 70 cm	Yes	10/100	46

4. CAREFLOW™ SINGLE LUMEN WITH EXTENSION AND FLOSWITCH*

	681615	2.5Fr (22G)	6 cm	N/A	N/A	20G	4.5 cm	22G	4 cm	0.5 x 35 cm		5/50	12
	681625	4Fr (18G)	6 cm	N/A	N/A	20G	4.5 cm	22G	40 cm	0.5 x 35 cm		5/50	47

PRODUCT CONTENTS

1. Single lumen Careflow set with extension contents¹:

Careflow Polyurethane catheter with clear extension, extension slide clamp, cannula introducer, steel needle introducer, vessel dilator, Venaguide™ Seldinger wire-advancing device with Nitinol guidewire, Luer-Lok™ plug, secondary fixation device (where shown) and 5ml syringe.

2. Single lumen Careflow set with Floswitch contents:

Careflow Polyurethane catheter with clear extension, steel needle introducer, Floswitch® overneedle introducer, PTFE coated soft-tip straight guidewire and Floswitch revolving Luer-Lok system, luer lock plug.

3. Single lumen Careflow set with integral Floswitch contents:

Careflow Polyurethane catheter with clear extension and integral Floswitch, Floswitch overneedle introducer, steel needle introducer, vessel dilator, Venaguide Seldinger wire-advancing device with Nitinol guidewire, Luer-Lok plug and secondary fixation device.

4. Single lumen Careflow set with extension and Floswitch contents¹:

Careflow Polyurethane catheter with clear extension, steel needle introducer, Floswitch overneedle introducer, vessel dilator, Venaguide Seldinger wire-advancing device with Nitinol guidewire, Floswitch revolving Luer-Lok system and luer lock plug.



Careflow™ Central Venous Catheter Sets

Double & Triple Lumen

Sterile, single use

CAREFLOW™ DOUBLE LUMEN SETS

CODE WITHOUT FLOSWITCH*	CODE WITH FLOSWITCH*	EXTERNAL DIAMETER	LENGTH	CANNULA INTRODUCER		FLOSWITCH* INTRODUCER		NEEDLE INTRODUCER		GUIDEWIRE OD & LENGTH	SECONDARY FIXATION (SFD)	BOX/CASE CONTENT (UNITS)	FLOW RATE (ML/MIN)		
				GAUGE	LENGTH	GAUGE	LENGTH	GAUGE	LENGTH				D	M	P
681616	681617	4Fr (20G, 22G)	6 cm	20G	4.5 cm	20G	4.5 cm	22G	7 cm	0.5 x 35 cm		5/50	20		8
681626	681627	4Fr (20G, 22G)	10 cm	20G	4.5 cm	20G	4.5 cm	22G	7 cm	0.5 x 35 cm		5/50	19		6
681653	681652	4Fr (20G, 22G)	15 cm	20G	4.5 cm	20G	4.5 cm	22G	7 cm	0.5 x 45 cm		5/50	16		4
681656 [≠]	681655	4Fr (20G, 22G)	20 cm	20G	4.5 cm	20G	4.5 cm	22G	7 cm	0.5 x 45 cm		5/50	17		4
681619	681628	5Fr (18G, 20G)	6 cm	18G	6 cm	18G	6 cm	17G	7 cm	0.6 x 45 cm	Yes	5/50	40		10
681683	681682	5Fr (18G, 20G)	15 cm	18G	6 cm	18G	6 cm	17G	7 cm	0.6 x 45 cm	Yes	5/50	29		6
681687	681686	5Fr (18G, 20G)	20 cm	18G	6 cm	18G	6 cm	17G	7 cm	0.6 x 65 cm	Yes	5/50	30		6
681703	681702	7Fr (16G, 18G)	15 cm	16G	7 cm	15G	7 cm	17G	7 cm	0.9 x 45 cm	Yes	5/50	74		24
681714	681713	7Fr (16G, 18G)	20 cm	16G	7 cm	15G	7 cm	17G	7 cm	0.9 x 70 cm	Yes	5/50	73		21
681718	681717	7Fr (16G, 18G)	30 cm	16G	7 cm	15G	7 cm	17G	7 cm	0.9 x 70 cm	Yes	5/50	61		19

PRODUCT CONTENTS

Double lumen Careflow with Floswitch set contents:

Careflow double lumen Polyurethane catheter with clear extensions, steel needle introducer, Floswitch overneedle introducer, vessel dilator, Venaguide™ Seldinger wire-advancing device with Nitinol guidewire, Floswitch revolving Luer-Lok system, luer lock plugs and secondary fixation device (where shown).

Double lumen Careflow without Floswitch set contents:

Careflow double lumen Polyurethane catheter with clear extensions, cannula introducer, steel needle introducer, vessel dilator, Venaguide Seldinger wire-advancing device with Nitinol guidewire, extension slide clamps, 5ml syringe, luer lock plugs and secondary fixation device (where shown). [≠] Note: Part number 681656 contains 0.5 x 650mm guidewire.

CAREFLOW™ TRIPLE LUMEN SETS

CODE WITHOUT FLOSWITCH*	CODE WITH FLOSWITCH*	EXTERNAL DIAMETER	LENGTH	CANNULA INTRODUCER		FLOSWITCH* INTRODUCER		NEEDLE INTRODUCER		GUIDEWIRE OD & LENGTH	SECONDARY FIXATION (SFD)	BOX/CASE CONTENT (UNITS)	FLOW RATE (ML/MIN)		
				GAUGE	LENGTH	GAUGE	LENGTH	GAUGE	LENGTH				D	M	P
681620	681629	5Fr (18G, 20G, 20G)	6 cm	18G	6 cm	18G	6 cm	17G	7 cm	0.6 x 45 cm	Yes	5/50	40	10	12
681630	681618	5Fr (18G, 20G, 20G)	10 cm	18G	6 cm	18G	6 cm	17G	7 cm	0.6 x 45 cm	Yes	5/50	32	7	8
681691	681690	5Fr (18G, 20G, 20G)	15 cm	18G	6 cm	18G	6 cm	17G	7 cm	0.6 x 45 cm	Yes	5/50	29	5	6
681695	681694	5Fr (18G, 20G, 20G)	20 cm	18G	6 cm	18G	6 cm	17G	7 cm	0.6 x 65 cm	Yes	5/50	26	5	5
681721	681720	7Fr (16G, 18G, 18G)	15 cm	16G	7 cm	15G	7 cm	17G	7 cm	0.9 x 40 cm	Yes	5/50	66	22	23
681725	681724	7Fr (16G, 18G, 18G)	20 cm	16G	7 cm	15G	7 cm	17G	7 cm	0.9 x 70 cm	Yes	5/50	59	16	17
681729	681728	7Fr (16G, 18G, 18G)	30 cm	16G	7 cm	15G	7 cm	17G	7 cm	0.9 x 70 cm	Yes	5/50	53	11	9

PRODUCT CONTENTS

Triple lumen Careflow with Floswitch set contents:

Careflow triple lumen Polyurethane catheter with clear extensions, steel needle introducer, Floswitch overneedle introducer, vessel dilator, Venaguide Seldinger wire-advancing device with Nitinol guidewire, Floswitch revolving Luer-Lok™ system, luer lock plugs and secondary fixation device.

Triple lumen Careflow without Floswitch set contents:

Careflow triple lumen Polyurethane catheter with clear extensions, cannula introducer, steel needle introducer, vessel dilator, Venaguide Seldinger wire-advancing device with Nitinol guidewire, extension slide clamps, 5ml syringe, luer lock plugs and secondary fixation device.



Careflow™ Central Venous Catheter Sets

Quad & Quint Lumen

Sterile, single use

CAREFLOW™ QUAD LUMEN SETS

CODE WITHOUT FLOSWITCH®	CODE WITH FLOSWITCH®	EXTERNAL DIAMETER	LENGTH	CANNULA INTRODUCER		FLOSWITCH® INTRODUCER		NEEDLE INTRODUCER		GUIDEWIRE OD & LENGTH	BOX/CASE CONTENT (UNITS)	FLOW RATE (ML/MIN)				
				GAUGE	LENGTH	GAUGE	LENGTH	GAUGE	LENGTH			D	M1	M2	P1	P2
681731	681732	8.5Fr (14G, 16G, 16G, 18G)	15 cm	16G	7 cm	15G	7 cm	17G	7 cm	0.9 x 45 cm	5/50	64	82	57	20	
681733	681734	8.5Fr (14G, 16G, 16G, 18G)	20 cm	16G	7 cm	15G	7 cm	17G	7 cm	0.9 x 70 cm	5/50	58	76	45	19	

PRODUCT CONTENTS

Quad lumen Careflow with Floswitch set contents:

Careflow quad lumen Polyurethane catheter with clear extensions, steel needle introducer, Floswitch overneedle introducer, vessel dilator, Venaguide™ Seldinger wire-advancing device with Nitinol guidewire, Floswitch revolving Luer-Lok™ system, scalpel, luer lock plugs and secondary fixation device.

Quad lumen Careflow without Floswitch set contents:

Careflow quad lumen Polyurethane catheter with clear extensions, cannula introducer, steel needle introducer, vessel dilator, Venaguide Seldinger wire-advancing device with Nitinol guidewire, extension slide clamps, 5ml syringe, scalpel, luer lock plugs and secondary fixation device.

CAREFLOW™ QUINT LUMEN SETS

CODE WITHOUT FLOSWITCH®	CODE WITH FLOSWITCH®	EXTERNAL DIAMETER	LENGTH	CANNULA INTRODUCER		FLOSWITCH® INTRODUCER		NEEDLE INTRODUCER		GUIDEWIRE OD & LENGTH	BOX/CASE CONTENT (UNITS)	FLOW RATE (ML/MIN)				
				GAUGE	LENGTH	GAUGE	LENGTH	GAUGE	LENGTH			D	M1	M2	P1	P2
681735	681736	9.5Fr (14G, 16G, 16G, 18G, 18G)	15 cm	16G	7 cm	15G	7 cm	17G	7 cm	0.9 x 45 cm	5/50	73	61	65	19	21
681737	681738	9.5Fr (14G, 16G, 16G, 18G, 18G)	20 cm	16G	7 cm	15G	7 cm	17G	7 cm	0.9 x 70 cm	5/50	68	58	60	13	12

PRODUCT CONTENTS

Quint lumen Careflow with Floswitch set contents:

Careflow quint lumen Polyurethane catheter with clear extensions, steel needle introducer, Floswitch overneedle introducer, vessel dilator, Venaguide Seldinger wire-advancing device with Nitinol guidewire, Floswitch revolving Luer-Lok system, scalpel, luer lock plugs and secondary fixation device.

Quint lumen Careflow without Floswitch set contents:

Careflow quint lumen Polyurethane catheter with clear extensions, cannula introducer, steel needle introducer, vessel dilator, Venaguide Seldinger wire-advancing device with Nitinol guidewire, extension slide clamps, 5ml syringe, scalpel, luer lock plugs and secondary fixation device.



ARTERIAL CATHETERS AND HEMOSTASIS

39 Arterial Catheters

40 Hemostasis



Careflow™ Arterial Catheters

Sterile, single use

CAREFLOW™ POLYURETHANE ARTERIAL CATHETER SETS

PRODUCT CODE	PRODUCT	CATHETER		NEEDLE INTRODUCER		GUIDEWIRE OD & LENGTH	BOX/CASE CONTENT (UNITS)	PRIMING VOLUME (ML)	FLOW RATE (ML/MIN)
		EXTERNAL DIAMETER	LENGTH	GAUGE	LENGTH				
681631	Radial artery set	2.5Fr (22G)	6 cm	22G	4 cm	0.5 x 25 cm	10/100	0.08	12.4
681646	Radial artery set	3Fr (20G)	6 cm	22G	4 cm	0.5 x 25 cm	10/100	0.08	24.0
681642	Femoral artery set	3Fr (20G)	20 cm	22G	4 cm	0.5 x 45 cm	10/100	0.14	15.4
681648	Femoral artery set	4Fr (18G)	20 cm	17G	7 cm	0.6 x 45 cm	10/100	0.24	35.8



PreludeSYNC™ Radial Compression Device

The Next Generation of Radial Compression
Sterile, single use

Not just a product, an experience.

The PreludeSYNC is a next generation Radial Compression Device that is personal, comfortable, and secure. The PreludeSYNC was designed to address the market need for improved patient comfort without compromising safety. This innovative radial compression device comes packaged with creative designs printed directly on the bands to personalize the patient experience.

COMPRESSION DEVICE WITH SYRINGE	PRELUDESYNC COMPRESSION DEVICE SIZE/DESCRIPTION	UNITS/BOX
SRB24AC	24 cm 20 mL (Specialized Connection)	5
SRB24MED	24 cm 20 mL (Standard Luer)	5
SRB29AC	29 cm 20 mL (Specialized Connection)	5
SRB29MED	29 cm 20 mL (Standard Luer)	5
STAND ALONE SYRINGES	SYRINGE PRELUDESYNC	UNITS/BOX
SRB20AC	20 mL (Specialized Connection)	10

SafeGuard® Pressure Assisted Device

The SafeGuard pressure assisted device delivers passive compression and enables immediate pressure adjustment. It also maintains consistent pressure on the site when obtaining hemostasis with manual compression, and during patient recovery, positioning and transport. The SafeGuard pressure assisted device reduces demands on the clinical staff, maximizes valuable resources, and enhances patient comfort.



82050

82000

Catalog Number	Size	Description
82000	24 cm	SafeGuard Pressure Assisted Device
82050	12 cm	SafeGuard Pressure Assisted Device

Packaged 10 units per box.

SAFEGUARD Radial™ Compression Device

The Safeguard Radial compression device is a 26 cm long, self-adhesive wristband that provides focused compression and assists patent hemostasis at the conclusion of radial procedures.

Catalog Number	Description	Quantity
SGR26	SAFEGUARD Radial	10 per box

Band length = 26 cm





FLUID MANAGEMENT

- 43 Manifolds
- 48 Stopcocks
- 49 Adapters
- 50 Fluid Administration Sets
- 52 Contrast Management Systems
- 57 Rapid Response Right Heart Kits
- 58 Flow Control Switch

Merit® Manifolds

Merit Manifolds have been designed to meet numerous clinician preferences. The clear polycarbonate material allows easy visibility for de-bubbling and the handles have been designed for ease of torque. In addition, options include one to five ports, 200 psi or 500 psi, 6" (15 cm) extension tubing and rotating luer, with block body or half body styles. Packaged 25 units per box, 4 boxes per case.

MANIFOLDS WITH RIGHT PORT ORIENTATION AND ROTATING LUER

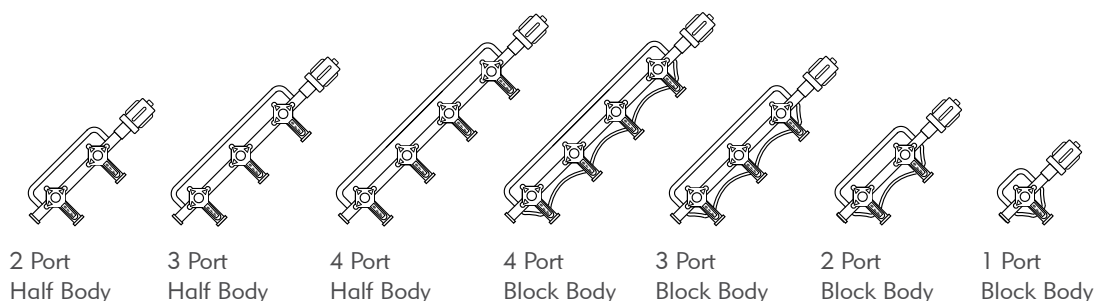

200 PSI (14 BAR)

ON Handles	202HN-R	203HN-R	204HN-R	204BN-R	203BN-R	202BN-R
Wide Port	202LHWN-R	203LHWN-R	204LHWN-R			
OFF Handles	202HF-R	203HF-R	204HF-R	204BF-R	203BF-R	202BF-R
Wide Port	202LHWF-R	203LHWF-R	204LHWF-R			
360/OFF Handles				204BF-RT	203BF-RT	
360/ON Handles					203BN-RT	

500 PSI (34 BAR)

ON Handles	502HN-R	503HN-R	504HN-R	504BN-R	503BN-R	502BN-R	501BN-R
Wide Port	502LHWN-R	503LHWN-R	504LHWN-R				
360/ON Handles		503HN-RT					
OFF Handles	502HF-R	503HF-R	504HF-R	504BF-R	503BF-R	502BF-R	501BF-R
Wide Port	502LHWF-R	503LHWF-R	504LHWF-R				
360/OFF Handles	502HF-RT				503BF-RT		

MANIFOLDS WITH LEFT PORT ORIENTATION AND ROTATING LUER

Packaged 25 units per box, 4 boxes per case.

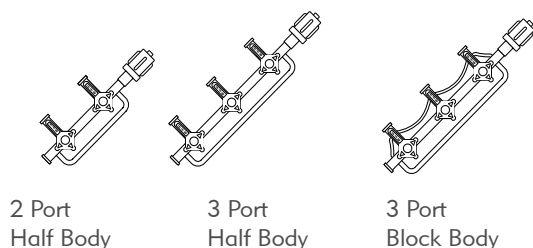

200 PSI (14 BAR)

ON Handles			203BN-L
OFF Handles	202HF-L	203HF-L	
			203BF-L

500 PSI (34 BAR)

OFF Handles	502HF-L	503HF-L
-------------	----------------	----------------

MANIFOLDS

MANIFOLDS WITH ALL FEMALE PORTS

Packaged 25 units per box, 4 boxes per case.

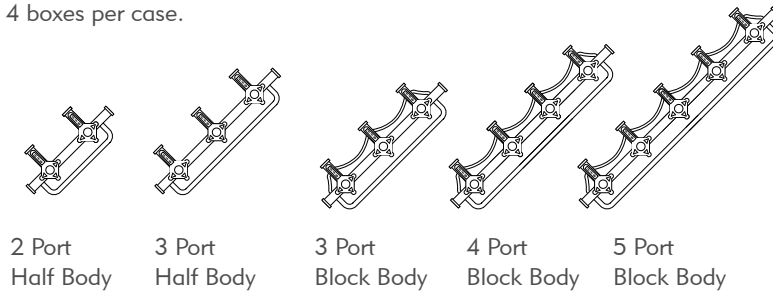

200 PSI (14 BAR)

ON Handles			203BN-F		
OFF Handles	202HF-F	203HF-F			205BF-F
360/OFF Handles			203BF-FT	204BF-FT	205BF-FT

500 PSI (34 BAR)

OFF Handles	503BF-F				
-------------	---------	--	--	--	--



205BF-F

MANIFOLDS WITH RIGHT PORT ORIENTATION, 6" (15 CM) TUBING EXTENSION AND ROTATING LUER

Packaged 25 units per box, 4 boxes per case.

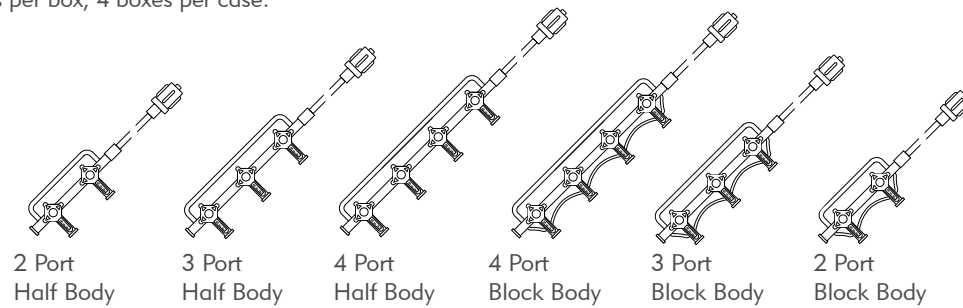

200 PSI (14 BAR)

ON Handles	202HN-RX	203HN-RX			
OFF Handles	202HF-RX	203HF-RX	204HF-RX	203BF-RX	
360/OFF Handles					203BF-RXT

500 PSI (34 BAR)

ON Handles			503HN-RX	502BN-RX	
OFF Handles	502LHWF-R	503HF-RX	504HF-RX	503BF-RX	502BF-RX
360/OFF Handles					503BF-RXT

Devos™ Manifolds

Devos Manifolds with check relief valve, right port orientation and rotating luer. TRAM® and TRAM-P™ manifold ports have the added benefit of an integrated transducer on the port closest to the rotating adapter with comfortable wide-spaced finger grips. Packaged 25 units per box, 4 boxes per case. TRAM and TRAM-P manifolds packaged 10 units per box, 4 boxes per case.

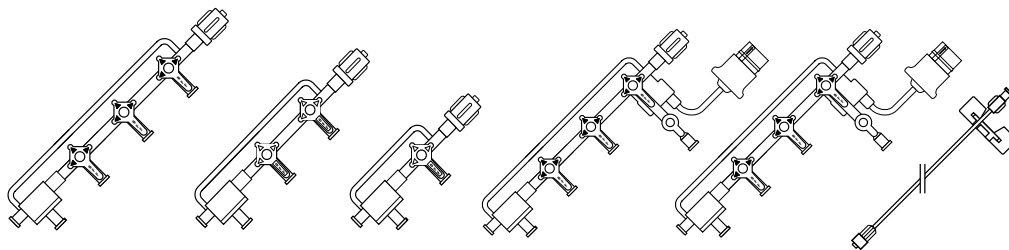

**4 Port
Half Body**

**3 Port
Half Body**

**2 Port
Half Body**

**4 Port
TRAM**

**4 Port
TRAM-P***

200 PSI (14 BAR)

OFF Handles	2V4LHWF-R	2V3HF-R	2V2HF-R	2V4LTPHWF-R	2V4LTCHWF-R
Tubing Extension	2V4LHWF-RXT				
360/OFF Handles	2V4LHWF-RT	2V3HF-RT	2V2HF-RT	2V4LTPHWF-RT	2V4LTCHWF-RT

*TRAM-P includes 48" (122 cm) Compensation Line and Clip



2V3HF-R

TRAM® Manifolds with Integrated Transducer

The TRAM Manifold with Integrated Transducer gives a single operator the convenience to de-bubble, zero and rezero within the sterile field. The TRAM has optimized clinician comfort by reducing hand fatigue with low torque, easy-to-turn wide-spaced handles, even when utilizing higher injection pressures. The Devos™ TRAM manifold has a check relief valve. Packaged 10 units per box, 4 boxes per case.

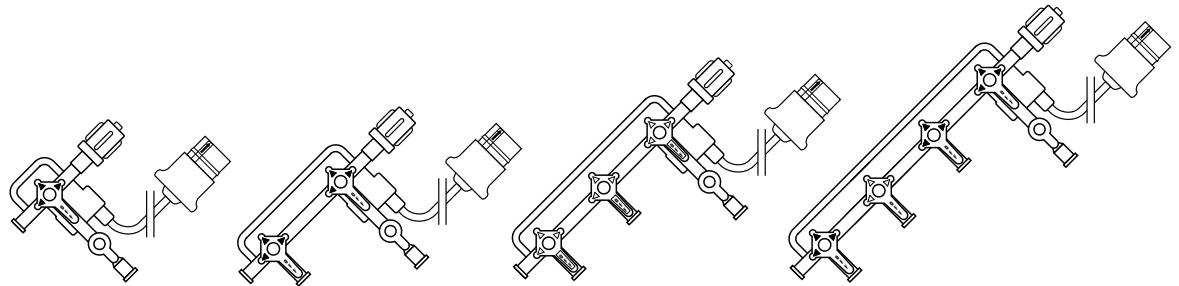

1 Port

2 Port

3 Port

4 Port

200 PSI (14 BAR)

ON Handles Wide				
Standard	201LTPHN-R		203LTPHN-R	
OFF Handles Wide		202LTPHWF-R	203LTPHWF-R	204LTPHWF-R
Devos				2V4LTPHWF-R
Devos with 360° handle				2V4LTPHWF-RT
Standard			203LTPHF-R	

500 PSI (34 BAR)

ON Handles Wide		502LTPHWN-R	503LTPHWN-R	504LTPHWN-R
Standard	501LTPHN-R		503LTPHN-R	
OFF Handles Wide		502LTPHWF-R	503LTPHWF-R	504LTPHWF-R
Standard			503LTPHF-R	

Tram-P™ Manifolds with Integrated Transducer

The TRAM-P features a pressure transducer on the first port. By positioning the compensation line on an IV pole rather than on a table, the TRAM-P maintains a constant calibrated reading. With this configuration, the manifold can be moved to any position without affecting the accuracy of the pressure reading. Comfortable wide-spaced finger grip option. The Devos™ TRAM-P manifold has a check relief valve. Packaged 10 units per box, 4 boxes per case.

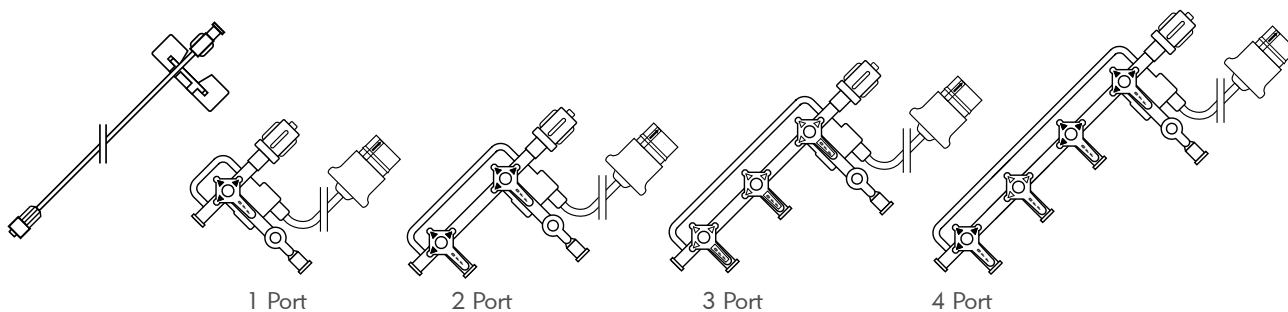

200 PSI (14 BAR)

ON Handles Wide		202LTCHWN-R	203LTCHWN-R	204LTCHWN-R
Standard	201LTCHN-R		203LTCHN-R	
OFF Handles Wide		202LTCHWF-R	203LTCHWF-R	204LTCHWF-R
Devos				22V4LTCHWF-R
Devos with 360° handle				2V4LTCHWF-RT
Standard			203LTCHF-R	

500 PSI (34 BAR)

ON Handles Wide		502LTCHWN-R	503LTCHWN-R	504LTCHWN-R
Standard	501LTCHN-R		503LTCHN-R	
OFF Handles Wide		502LTCHWF-R	503LTCHWF-R	504LTCHWF-R
Standard	501LTCHF-R		503LTCHF-R	

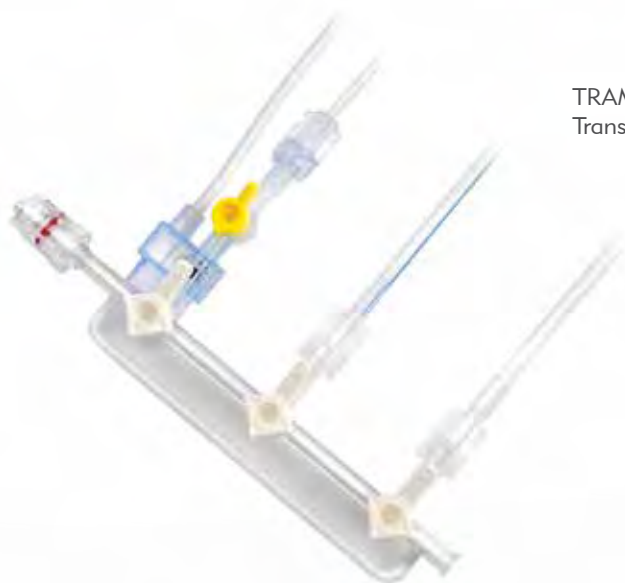

TRAM-P
Transducer and Manifold

Marquis® Series Stopcocks

Merit Medical's large, easy-grip handle makes a Marquis Stopcock effortless to grip and turn. Available in pressure ratings of 200, 500 and 1050 psi with easy-turning handles. Luer options include rotating, swivel nut, fixed and slip. Packaged 50 units per box, 4 boxes per case.



H1RC

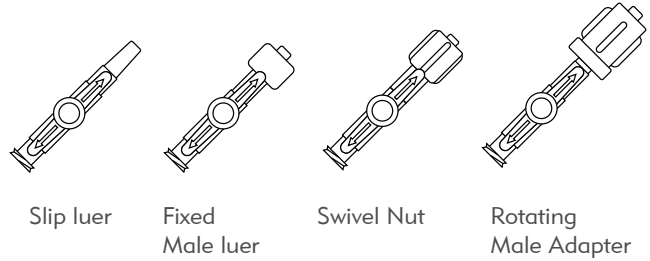

200 PSI (14 BAR)

1-way (white handle)	S1SLC	S1FLC	S1SNC
----------------------	-------	-------	-------

500 PSI (34 BAR)

1-way (light blue handle)	M1SLC	M1FLC	M1SNC
---------------------------	-------	-------	-------

1050 PSI (72 BAR)

1-way (dark blue handle)	H1FLC	H1SNC	H1RC
--------------------------	-------	-------	------

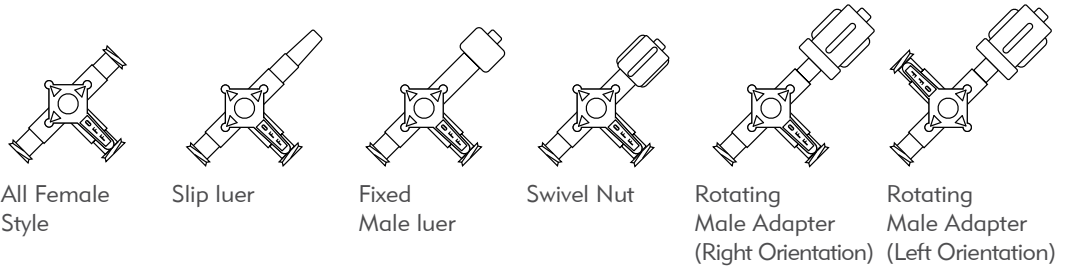

50 PSI (3.5 BAR)

3-way Large Bore	L3SNC
4-way Large Bore	L4SNC

200 PSI (14 BAR)

3-way (white handle)	S3FC	S3SLC	S3FLC	S3SNC
4-way (white handle)	S4SLC	S4FLC	S4SNC	

500 PSI (34 BAR)

3-way (light blue handle)	M3SLC	M3FLC	M3SNC	M3RRC	M3RLC
3-way (red handle)				M3RRC-R	
4-way (light blue handle)		M4FLC	M4SNC	M4RRC	

1050 PSI (72 BAR)

3-way (dark blue handle)	H3FLC	H3SNC	H3RRC	H3RLC
4-way (dark blue handle)	H4FLC	H4SNC	H4RRC	

1200 PSI (83 bar)

3-way (red handle)	U3RRC
--------------------	-------

Airless Rotating Adapters

Used as connectors between two devices. Luer rotates a full 360° preventing torque transfer between the two attaching devices. Enhances patient safety by minimizing the possibility of trapped air. Packaged 25 units per box, 4 boxes per case.



Male-Female
Rotating Adapter



Male-Male
Rotating Adapter

Catalog Number

MFA100

MMA100

Fluid Administration Sets

Merit offers a large variety of products for fluid delivery, including simple, single-line spike systems, complex multiple-line drip chambers with bifurcated or trifurcated lines, and large and small bore tubing with roller clamps or slide clamps. Products are available with micro- or macro-drip chambers, and with or without a micro filter. Custom fluid administration sets available.

FLUID ADMINISTRATION SET with user-selectable vented macro-drip chamber and small bore tubing. Packaged 25 units per box, 4 boxes per case.

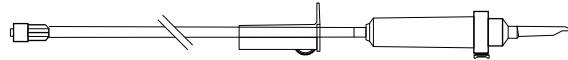

	48" Length (122 cm)	60" Length (152 cm)	72" Length (183 cm)	108" Length (274 cm)
Catalog Number for without Micro Filter	FAS1048	FAS1060	FAS1072	FAS1108
Catalog Number for with Micro Filter		FAS1160	FAS1172	

FLUID ADMINISTRATION SET with non-vented macro-drip chamber, micro filter and small bore tubing. Packaged 25 units per box, 4 boxes per case.



	60" Length (152 cm)	72" Length (183 cm)
Catalog Number	FAS1260	FAS1272

FLUID ADMINISTRATION SET with user-selectable vented spike. Packaged 25 units per box, 4 boxes per case.

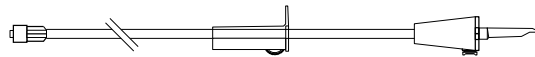

	48" Length (122 cm)	60" Length (152 cm)	72" Length (183 cm)	108" Length (274 cm)
Catalog Number for Small Bore Tubing	FAS4048	FAS4060	FAS4072	FAS4108
Catalog Number for Large Bore Tubing	FAS5048	FAS5060	FAS5072	FAS5108

FLUID ADMINISTRATION SET with spike and large bore tubing. Packaged 25 units per box, 4 boxes per case.

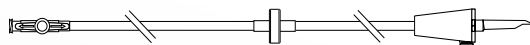

20" Length (51 cm)
With single disk check valve
and user-selectable vented spike



48" Length (122 cm)
with pinch clamp
and non-vented spike

Catalog Number	K08-02181	FAS5248
-----------------------	-----------	---------

FLUID ADMINISTRATION SPIKE with user-selectable vent, 1" (2.5 cm) small bore tubing and port protectors. Packaged 25 units per box, 4 boxes per case.

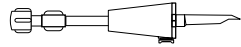

Female luer

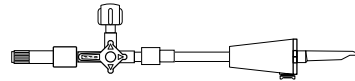

3-way Marquis® Stopcock

Catalog Number

CAS100

CAS200

FLUID ADMINISTRATION SET with vented macro-drip chamber with ball, 72" large bore tubing. Single-patient use for fluid or contrast management. Packaged 25 units per box, 4 boxes per case.



72" Length (183 cm)

Catalog Number

K08-02385

FLUID MANAGEMENT TUBE 20" (50 cm) small bore tubing with small bore male slip luer. Packaged 15 units per box, 4 boxes per case.



Catalog Number K08-01859

FLUID ADMINISTRATION SET with user-selectable vented macro-drip chamber, micro filter, roller clamps and small bore tubing. Packaged 25 units per box, 4 boxes per case.

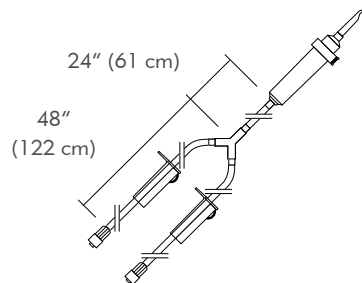

Bifurcated
72" Length (183 cm)

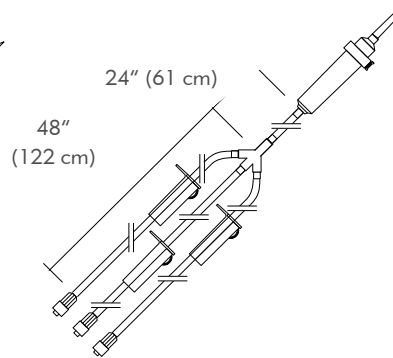

Trifurcated
72" Length (183 cm)

Catalog Number

FAS2572

FAS3072

FLUID ADMINISTRATION SETS

FLUID ADMINISTRATION SET with user-selectable vented spike, roller clamps and small bore tubing. Packaged 25 units per box, 4 boxes per case.

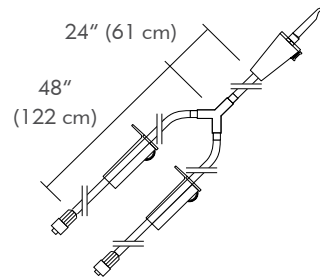

Bifurcated
72" Length (183 cm)

Catalog Number FAS6072



Pressurized Contrast Administration Systems

Features one-way piercing Sosa spike and large bore tubing. Packaged 15 units per box, 4 boxes per case.

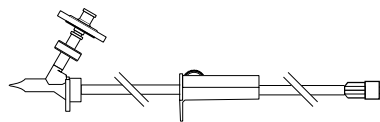

72" Length (183 cm)

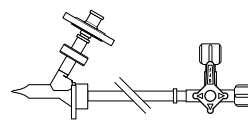

6.5" Length (17 cm)

Catalog Number K08-00006

K08-00685A

Contrast Management Systems

Spike with large bore tubing, bonded Marquis® Stopcock and vented sideport protectors. Packaged 25 units per box, 4 boxes per case.

Catalog Number

K08-02438

Vented spike, large bore with user-selectable vent. 1" large bore tubing, 1-way stopcock with distal female luer.

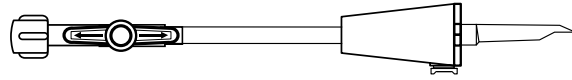

Catalog Number

K08-02384

Vented spike, large bore with user-selectable vent. 2" large bore tubing, 3-way stopcock with distal female luer.

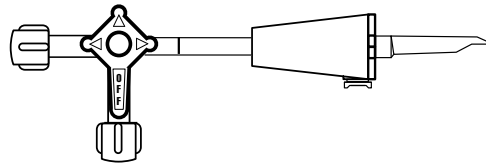

Catalog Number

K08-00417B

Vented spike, large bore with user-selectable vent. 6.5" large bore tubing, 3-way stopcock with distal female luer.

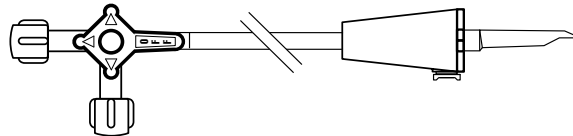

Catalog Number

K08-00077B

Vented spike, large bore with user-selectable vent. 2" large bore tubing, 1-way stopcock with distal male luer.

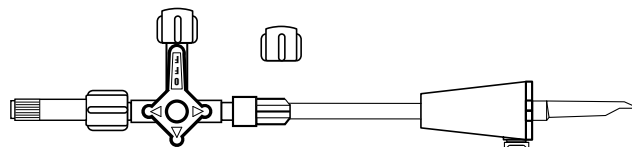

Catalog Number

K08-00078A

Vented spike, large bore with user-selectable vent. 2" large bore tubing, 3-way stopcock with distal male luer.

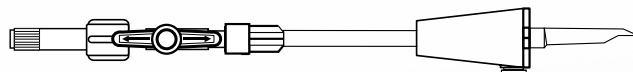

Contrast Management Systems

Catalog Number

K08-00577

Macro Drip Chamber with filter, large bore, with 6.5" large bore tubing, 3-way stopcock with distal female luer.

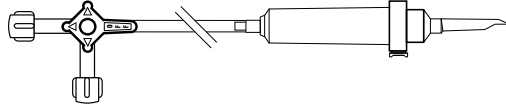

Catalog Number

K08-01878B

Merit CT Contrast Management spike with 20" (50 cm) large bore tubing, large bore vented spike, dual check valve, and fixed male luer. Packaged 20 units per box, 4 boxes per case.

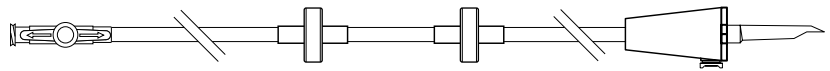

Catalog Number

K08-00719

Vented spike, large bore with vent. 1" large bore tubing, 3-way stopcock with distal female luer.

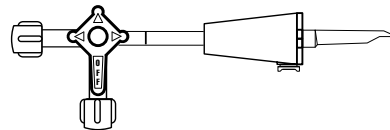

CT Transfer Sets

Catalog Number

K08-01961B

Vented, valved spike with 20" (50 cm) small bore tubing and nexus Luer. Packaged 25/box, 4 boxes/case.

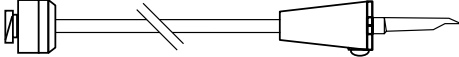

Catalog Number

K08-02195A

Vented, valved spike with 20" (50 cm) small bore blue stripe tubing and nexus Luer. Packaged 25/box, 4 boxes/case.

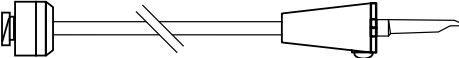

Miser® Contrast Management Systems

The Miser Contrast Management System’s exclusive orange ball and burette design prevents air from entering fluid lines during angiography, ensuring patient safety. The dual one-way check valve’s microbial barrier blocks cross contamination. Automatic refill during each contrast withdrawal allows for quick and easy preparation.

MISER CONTRAST MANAGEMENT SYSTEM

Includes 72" (183 cm) distal tubing, 2 one-way check valves, 30 mL burette, air-inlet valve. Configurations available with and without a distal stopcock and with large or small bore distal tubing. Packaged 10 units per box, 4 boxes per case.

CATALOG NUMBER	DESCRIPTION
MISER1	Large Bore Tubing without Stopcock
MISER2	Large Bore Tubing with Stopcock
MISER3	Small Bore Tubing without Stopcock
MISER4	Small Bore Tubing with Stopcock



MISER CONTRAST MANAGEMENT BURETTE SPIKE

Includes large bore piercing spike, 30 mL burette, air-inlet valve, large bore distal 3-way stopcock with female luers. **MUST BE USED IN CONJUNCTION WITH K08-00422D** (shown below). Packaged 10 units per box, 4 boxes per case.

CATALOG NUMBER MISER5



MERIT IN-LINE CONTRAST MANAGEMENT SYSTEM

Includes 54" (137 cm) large bore tubing, 2 one-way check valves, standard pressure 3-way stopcock and fixed male luers. Packaged 10 units per box, 4 boxes per case.

CATALOG NUMBER K08-00422D



Rapid Response Right Heart Kits

Right Heart Kits are pre-assembled and include necessary pressure monitoring and fluid management components.

RAPID RESPONSE RIGHT HEART ON KIT

2-port manifold, ON handle with transducer, 60" (152 cm) pressure monitoring tubing, and 60" (152 cm) non-vented small bore tubing flush line. Packaged 10 units per box, 4 boxes per case.

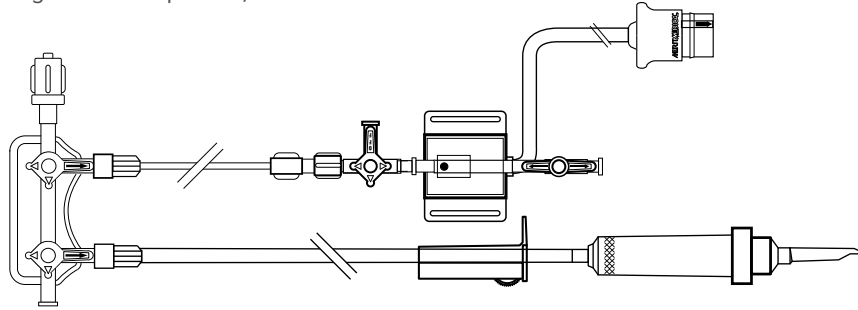

Catalog Number K09-10471

RAPID RESPONSE RIGHT HEART OFF KIT

2-port manifold, OFF handle with transducer, 60" (152 cm) pressure monitoring tubing, and 60" (152 cm) non-vented small bore tubing flush line. Packaged 10 units per box, 4 boxes per case.

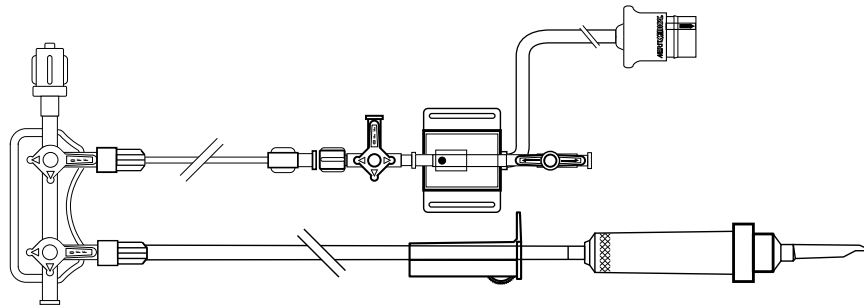

Catalog Number K09-10472

All components within the kit require market authorization in the country of sale.

Flow Control Switch

The Merit Medical Flow Control Switch gives you the confidence you need when stopping and starting flow during critical procedures. This feature-rich, integrated, one-handed, single-channel device is designed with clinician and patient safety in mind. Merit’s High Pressure Flow Control Switch can be used with any application that involves liquid flow and requires inline shut off capability.

- Audible switch ensures ease of use and confirmation of open/close
- High pressure capable of pressures up to 1200 psi in dynamic (ON) applications
- On/Off slider switch one-handed actuation
- Customization options available

CATALOG

NUMBER	DESCRIPTION	SLIDER COLOR	BOX QUANTITY
U1SHC	Flow Control Switch	Blue	24
U1SHC-W	Flow Control Switch	White	24
U1SHC-R	Flow Control Switch	Red	24
U1SHC-Y	Flow Control Switch	Yellow	24
U1SHC-G	Flow Control Switch	Green	24

Pressure Rating: Open 1200 psi, Closed 150 psi

Lumen I.D.: 0.065 inches

Connectors: Male to Female



FOR INTERNAL USE ONLY

FLUID MANAGEMENT



TUBING

60 High Pressure Tubing

61 Pressure Monitoring Tubing

TUBING

High Pressure Tubing

Merit offers three specific material configurations ranging from highly flexible polyurethane to clear PVC to meet your specific pressure needs. Merit's high pressure tubing configurations offer both a fixed male connector and a rotating adapter connector.

CONTRAST INJECTION TUBING, POLYURETHANE, FLEXIBLE BRAIDED

Rated at 1200 psi (83 bar). Packaged coiled, 25 units per box, 4 boxes per case.

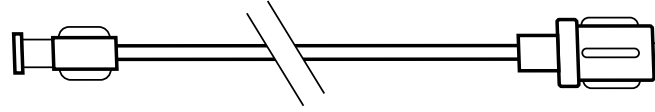

Male to Female	10" Length (25 cm)	20" Length (51 cm)	30" Length (76 cm)	48" Length (122 cm)	60" Length (152 cm)	72" Length (183 cm)
Airless Rotating Adapter	HPF100E	HPF200E	HPF300E	HPF480E		HPF720E
With KEEP™ Tubing Clip		HPF200K	HPF300K	HPF480K	HPF600K	HPF720K
Fixed Male Connector	HPF101E	HPF201E	HPF301E	HPF481E		HPF721E
With KEEP Tubing Clip		HPF201K	HPF301K	HPF481K	HPF601K	HPF721K

CONTRAST INJECTION TUBING, PVC, CLEAR

Rated at 1200, 900 and 500 psi (83, 62 and 34 bar). Packaged straight, 25 units per box, 4 boxes per case.

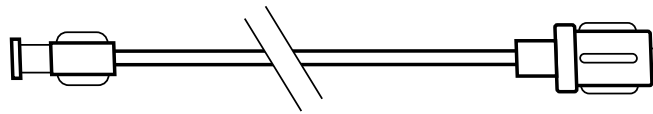

Male to Female	10" Length (25 cm)	20" Length (51 cm)	30" Length (76 cm)	48" Length (122 cm)	59" Length (150 cm)	72" Length (183 cm)
Airless Rotating Adapter						
1200 psi (83 bar)	HPT100E	HPT200E	HPT300E	HPT480E	HPT590E	
900 psi (62 bar)	HP9100E	HP9200E	HP9300E	HP9480E		HP9720E
500 psi (34 bar)	HP5100E	HP5200E	HP5300E	HP5480E		

Fixed Male Connector

1200 psi (83 bar)	HPT101E	HPT201E	HPT301E	HPT481E	HPT591E	
900 psi (62 bar)	HP9101E	HP9201E	HP9301E	HP9481E		HP9721E
500 psi (34 bar)	HP5101E	HP5201E	HP5301E	HP5481E		

CONTRAST INJECTION TUBING, FLEXIBLE, NYLON / POLYURETHANE, EXCITE™

Rated at 1200 psi (83 bar). Packaged straight, 25 units per box, 4 boxes per case.

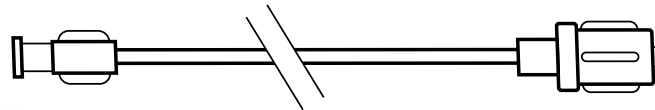

Male to Female	10" Length (25 cm)	20" Length (51 cm)	30" Length (76cm)	39" Length (100 cm)	48" Length (122 cm)	59" Length (150 cm)	72" Length (183 cm)
Airless Rotating Adapter	HPC100E	HPC200E	HPC300E	HPC390E	HPC480E	HPC590E	HPC720E
Fixed Male Connector	HPC101E	HPC201E	HPC301E	HPC391E	HPC481E	HPC591E	HPC721E

Pressure Monitoring Tubing

PRESSURE MONITORING TUBING PVC, RIGID NON-EXPANDING

Packaged coiled, 25 units per box, 4 boxes per case.

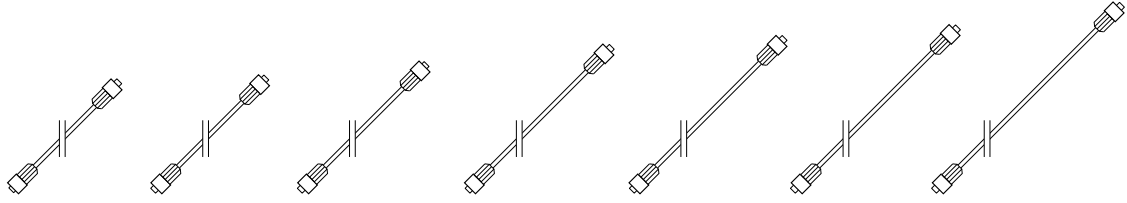

Male to Male	6" Length (15 cm)	12" Length (30 cm)	24" Length (61 cm)	36" Length (91 cm)	48" Length (122 cm)	60" Length (152 cm)	72" Length (183 cm)
Catalog Number	PM6006	PM6012	PM6024	PM6036	PM6048	PM6060	PM6072

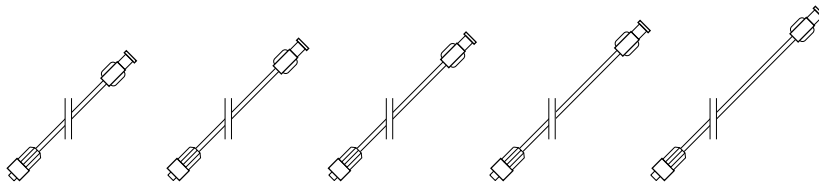

Male to Female	6" Length (15 cm)	12" Length (30 cm)	24" Length (61 cm)	36" Length (91 cm)	48" Length (122 cm)
Catalog Number	PM6106	PM6112	PM6124	PM6136	PM6148

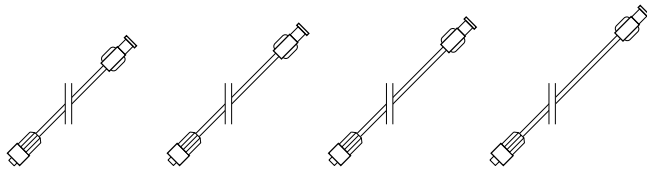

Male to Female	60" Length (152 cm)	72" Length (183 cm)	84" Length (213 cm)	96" Length (244 cm)
Catalog Number	PM6160	PM6172	PM6184	PM6196



SAFETY & INFECTION CONTROL

- 63** DualCap® Disinfection & Protection System
- 64** Syringes
 - 64** Coronary Control Syringes
 - 66** Vaclok®
 - 67** Medallion®
- 70** Safety and Waste Management
 - 70** Futura® Safety Scalpel
 - 71** BackStop® & BackStop Plus™
 - 71** MiniStop® & MiniStop Plus™
 - 71** ShortStop® & ShortStop Plus® & Grandstand®
 - 73** DriPAD™
- 74** Pen & Labels



DualCap®

Disinfection & Protection System

Sterile, single use

The DualCap System is a uniquely designed disinfecting cap system for use on both the male luer connector at the end of the IV tubing and the needle-free valve. The DualCap System consists of two caps designed to help prevent intraluminal contamination, as well as device cross-contamination, especially important for IV catheter use over extended dwell times.

- Disinfects rapidly and automatically at both IV catheter points
- The only male luer connector cap that prevents IPA from entering the fluid path
- Locks in ongoing protection against intravascular infections
- Easy to grasp
- Durable IV Pole Strips™ designed to withstand handling and provide convenient bedside delivery
- Supports infection control goals



CATALOG NUMBER	DESCRIPTION	CAPS PER BOX	BOX PER CASE	TOTAL CAPS PER CASE
001-300	DualCap® Solo™ Cap with foil lid for needle-free valve, packed in dispenser box.	350	12	4200
001-400	DualCap® IV Pole Strips™ Cap with foil lid for male luer connector, packed in dispenser box.	200	12	2400
500-LB	DualCap® IV Pole Strips™ For needle-free valves. 35 strips/10 caps per strip.	350	12	4200
600-DB	DualCap® IV Pole Strips™ For needle-free valves. 35 strips/5 caps per strip.	175	6	1050

CCS™ Coronary Control Syringes

The CCS Coronary Control Syringe has a clear barrel for clarity and smoothness and a solid plunger body to maintain stability and durability under pressure. The rotating and fixed luers allow flexibility and confidence in the luer connection. The specially designed safety space limits the potential for introducing air bubbles into the catheter. The CCS locking ring permits vacuum or negative pressure. The Inject8™ and Inject10™ offer clinicians more pressure with less applied force. Packaged 25 units per box, 4 boxes per case.

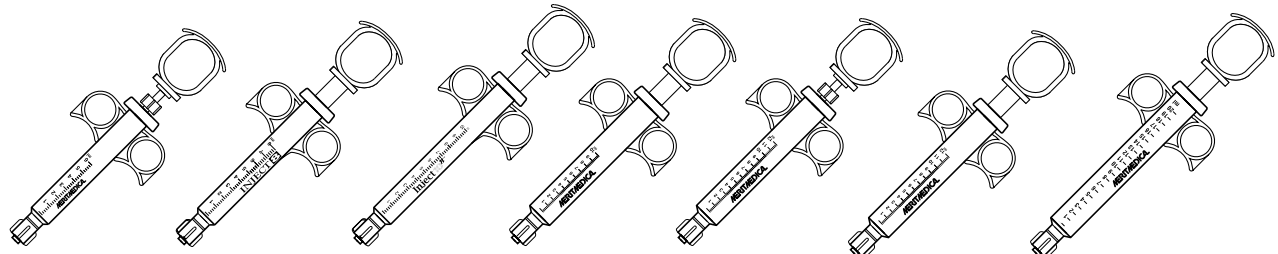

6 mL Locking Ring Plunger	8 mL Solid Plunger Inject8™	10 mL Solid Plunger Inject10™	10 mL Solid Plunger	12 mL Locking Ring Plunger	12 mL Solid Plunger	20 mL Solid Plunger
---------------------------------	-----------------------------------	-------------------------------------	---------------------------	----------------------------------	---------------------------	---------------------------

Rotating Adapter

CCS460	CCS880	CCX010	CCS800	CCS100	CCS600	CCS320
--------	--------	--------	--------	--------	--------	--------

Fixed Male Connector

CCS461	CCS881	CCX011	CCS801	CCS101	CCS601	CCS321
--------	--------	--------	--------	--------	--------	--------



ST800

SMART TIP™ CONTROL SYRINGE with blue silicone tip, ring plunger and ring grip. Packaged 25 units per box, 4 boxes per case.

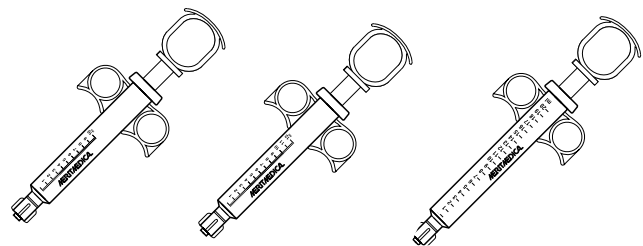

10 mL Solid Plunger	12 mL Solid Plunger	20 mL Solid Plunger
------------------------	------------------------	------------------------

Rotating Adapter

ST800	ST600	ST320
-------	-------	-------

Fixed Male Connector

ST801	ST601	ST321
-------	-------	-------

CORONARY CONTROL SYRINGE with palm pad plunger and ring grip. Packaged 25 units per box, 4 boxes per case.

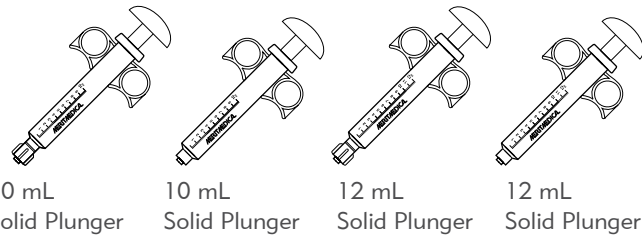

10 mL Solid Plunger 10 mL Solid Plunger 12 mL Solid Plunger 12 mL Solid Plunger

Rotating Adapter CCSB900 CCSB700

Fixed Male Connector CCSB901 CCSB701

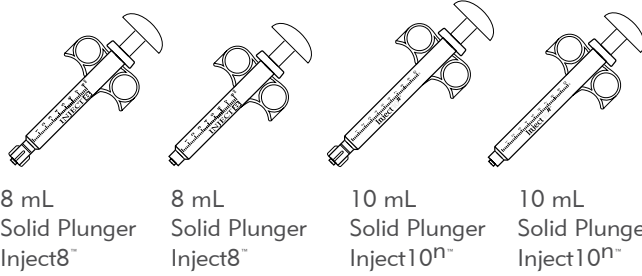

8 mL Solid Plunger Inject8™ 8 mL Solid Plunger Inject8™ 10 mL Solid Plunger Inject10™ 10 mL Solid Plunger Inject10™

Rotating Adapter CCSB880 CCXB010

Fixed Male Connector CCSB881 CCXB011



CCSB900

CORONARY CONTROL SYRINGE with palm pad plunger and wing grip. Packaged 25 units per box, 4 boxes per case.

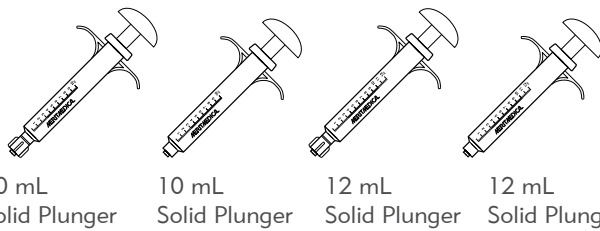

10 mL Solid Plunger 10 mL Solid Plunger 12 mL Solid Plunger 12 mL Solid Plunger

Rotating Adapter CCSB910 CCSB710

Fixed Male Connector CCSB911 CCSB711

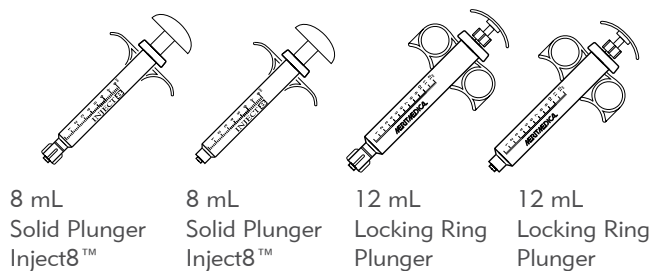

8 mL Solid Plunger Inject8™ 8 mL Solid Plunger Inject8™ 12 mL Locking Ring Plunger 12 mL Locking Ring Plunger

Rotating Adapter CCSW880 CCS200

Fixed Male Connector CCSW881 CCS201

VacLok® Vacuum Pressure Syringes

The VacLok vacuum pressure syringe comes with a clear polycarbonate barrel, white plunger, four- or six-position locking mechanism and fixed male luer. Packaged 20 or 25 units per box, 4 boxes per case.



10 mL
four position
25/box

20 mL
four position
20/box

30 mL
six position
20/box

60 mL
six position
25/box

Catalog Number

VAC110

VAC120

VAC130

VAC160

Medallion® Syringes

Merit Medical's Medallion Syringes come in seven color options with custom printing or a frosted field for writing information directly on the syringe barrel. The Medallion Syringe features a clear polycarbonate barrel, colored plunger, and fixed male Luer. Packaged 25 units per box, 4 boxes per case.



MSS011-LG

Plunger Colors	1 mL	3 mL	6 mL	10 mL	20 mL	30 mL	60 mL
----------------	------	------	------	-------	-------	-------	-------

White	MSS011	MSS031	MSS061	MSS111	MSS121	MSS131	MSS160
Light Blue	MSS011-LB	MSS031-LB	MSS061-LB	MSS111-LB	MSS121-LB	MSS131-LB	
Yellow	MSS011-Y	MSS031-Y	MSS061-Y	MSS111-Y	MSS121-Y	MSS131-Y	
Red	MSS011-R	MSS031-R	MSS061-R	MSS111-R	MSS121-R	MSS131-R	
Light Green	MSS011-LG	MSS031-LG	MSS061-LG	MSS111-LG	MSS121-LG	MSS131-LG	
Dark Green	MSS011-DG	MSS031-DG	MSS061-DG	MSS111-DG	MSS121-DG	MSS131-DG	
Purple	MSS011-PR	MSS031-PR	MSS061-PR	MSS111-PR	MSS121-PR	MSS131-PR	

MEDALLION SYRINGES with clear polycarbonate barrel, colored plunger, black medication printing, and fixed male Luer. Packaged 25 units per box, 4 boxes per case.



Plunger Colors	NITRO (10 mL)	LIDOCAINE (10 mL)	HEPARIN (10 mL)	CONTRAST (10 mL)	SALINE (10 mL)
----------------	---------------	-------------------	-----------------	------------------	----------------

Light Blue	K01-60085	K01-60081	K01-60082	K01-60086	K01-60083
Yellow	K01-60101	K01-60097	K01-60098	K01-60102	K01-60099
Red	K01-60109	K01-60105	K01-60106	K01-60110	
White	K01-60077			K01-60078	K01-60075
Light Green	K01-60093	K01-60089	K01-60090	K01-60094	
Dark Green				K01-00786	

Plunger Colors	FENTANYL (3 mL)	XYLOCAINE (10 mL)	VERSED (3 mL)	FLUSH (10 mL)
----------------	-----------------	-------------------	---------------	---------------

Light Blue		K01-00917	K01-05185	K01-05093
Red		K01-00953		
Light Green	K01-03243			

SAFETY & INFECTION CONTROL

Medallion® Sword handle Syringes

Medallion Sword Handle Syringes feature sword handles, clear polycarbonate barrels, colored plungers, and fixed male Luers. Packaged 25 units per box, 4 boxes per case.

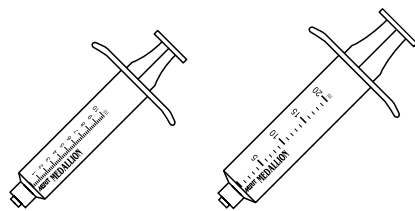

Plunger Colors	10 mL	20 mL
White	MSSW11	MSSW21
Light Blue	MSSW11-LB	MSSW21-LB
Yellow	MSSW11-Y	MSSW21-Y
Red	MSSW11-R	MSSW21-R
Light Green	MSSW11-LG	MSSW21-LG
Dark Green	MSSW11-DG	MSSW21-DG
Purple	MSSW11-PR	MSSW21-PR



MSSW11-Y

Custom Medallion® Syringes

Merit Medical's signature Medallion Syringes can be custom ordered to your specifications. Medallion Syringes come with a clear polycarbonate barrel, colored plunger, customised medication printing, and Luer options including fixed male or slip Luer styles.

Select one option from each category and identify your custom medication to be printed on the barrel. Your Merit Representative will provide you with the corresponding catalog number.

Custom Medallion Syringes are packaged 25 units per box, 4 boxes per case.

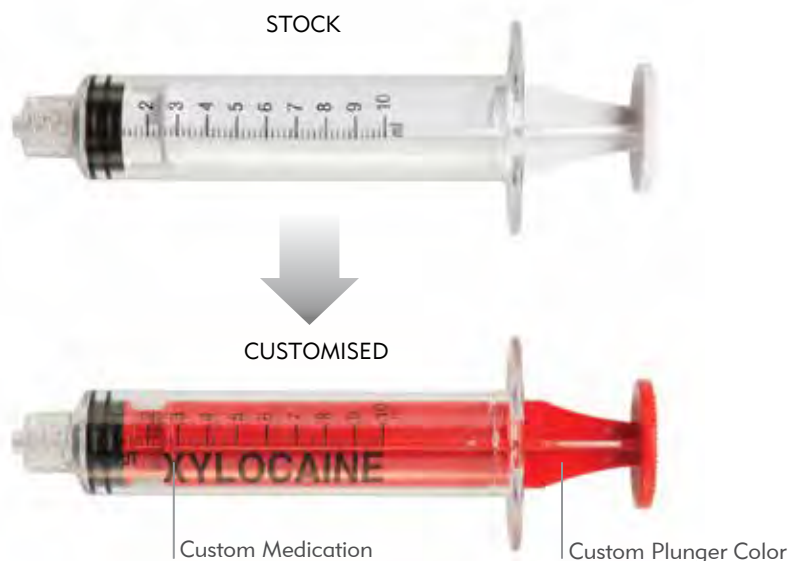

SIZE OPTIONS

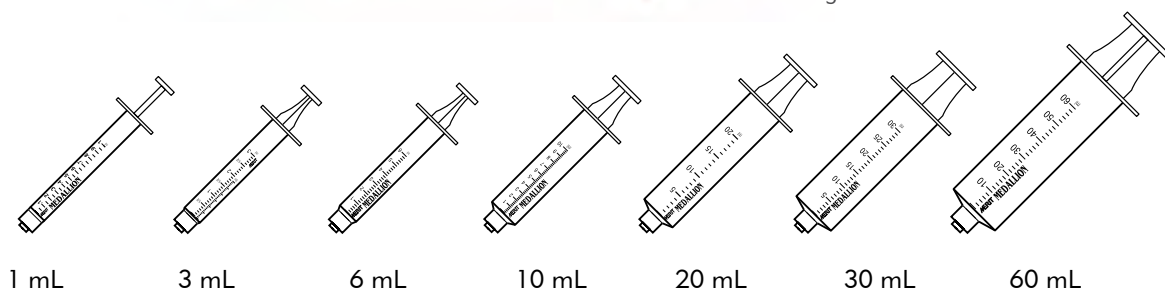

PLUNGER COLOR OPTIONS:

- White
- Light Blue
- Light Green
- Dark Green
- Yellow
- Red
- Purple

PRINT COLOR OPTIONS:

- Black
- White

LUER OPTIONS:

- Fixed Male Luer
- Slip Luer

SAFETY & INFECTION CONTROL

Futura® Safety Scalpels

These retractable safety scalpels are designed to protect clinicians and patients from accidental cuts during passing and disposal. The one-handed operation combines convenience with rapid response for any procedure. Packaged 50 units per box, 2 boxes per case.

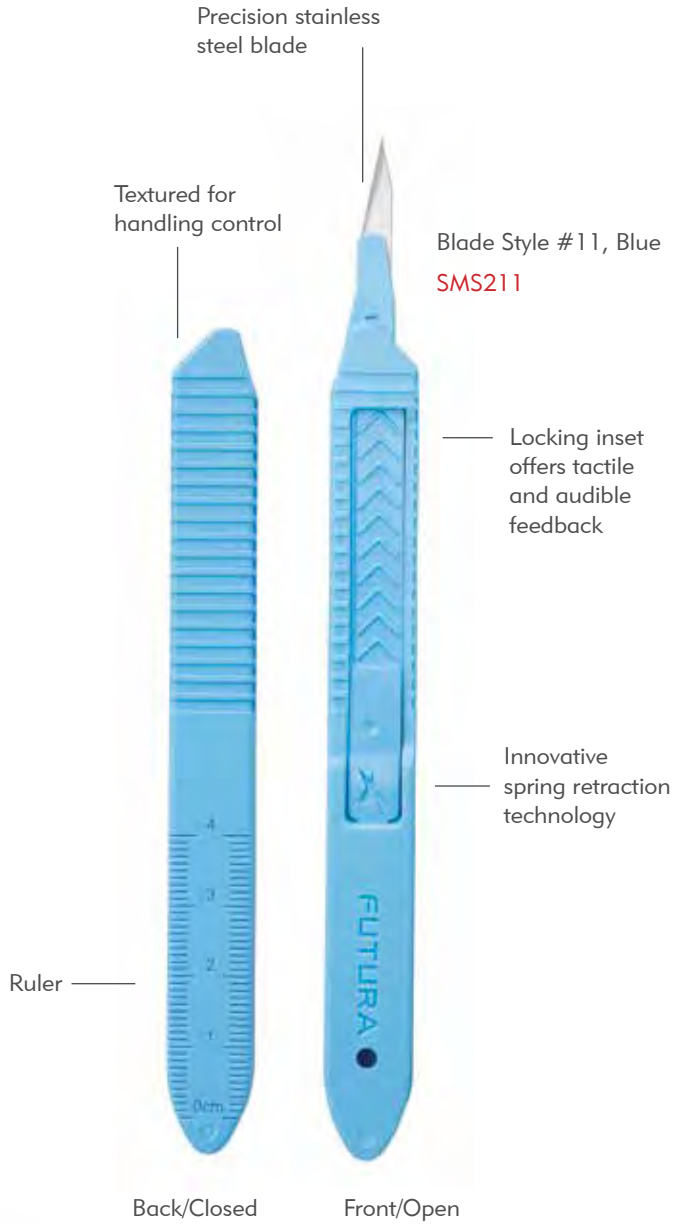

Blade Style #15, Yellow
SMS215



Blade Style #10, Green
SMS210

Catalog Number	Description	Color
SMS210	#10 Blade Style	green
SMS211	#11 Blade Style	blue
SMS215	#15 Blade Style	yellow

BACKSTOP® AND MINISTOP® DISPOSAL SYSTEMS

For quick and safe fluid waste elimination. Includes absorbent material and particulate-free, die-cut sponge and seal-tight lid.

Catalog Number	Description
MBS100	BackStop 500 mL fluid capacity, packaged 10 per box
MMS100	MiniStop 100 mL fluid capacity, packaged 20 per box
MMSF200	MiniStop filter, packaged 20 per box



MBS100

BACKSTOP+™ AND MINISTOP+™ DISPOSAL SYSTEMS

For quick and safe fluid waste elimination. Has a seal-tight lid to prevent fluid leakage after a procedure and includes a temporary sharps holder.

Catalog Number	Description
MBSP100	BackStop+ 500 mL fluid capacity, packaged 10 per box
MMSP100	MiniStop+ 100 mL fluid capacity, packaged 20 per box



MBSP100

DUGOUT® CLOSED WASTE BASINS

With 1000 mL fluid capacity and absorbent material. Includes particulate-free, die-cut sponge, secondary compartment for storage of ancillary products or saline, and seal-tight lid. Packaged 6 units per box, 4 boxes per case.

Catalog Number	Description
DUG100	DugOut 1000 mL fluid capacity
DUG1SS	DugOut 1000 mL fluid capacity with ShortStop® Temporary Sharps Holder



DUG100

SHORTSTOP® TEMPORARY SHARPS HOLDER

Reduce the possibility of accidental sharps injuries. Rigid, puncture-resistant material reduces potential of needle sticks and increases safety during disposal. Coring-resistant foam provides easy removal and minimizes particulate.

Catalog Number SS10

Packaged 25 per box, 4 boxes per case.



SS10

SHORTSTOP ADVANTAGE® TEMPORARY SHARPS HOLDER

The ShortStop Advantage temporary sharps holder features a new side access to rest a fully loaded syringe attached to a needle.

Catalog Number SS20

Packaged 25 per box, 4 boxes per case.



SHORTSTOP GRANDSTAND® TEMPORARY SHARPS HOLDER

The ShortStop Grandstand holds sharp devices upright for convenient access and safety. The compact configuration is a space-saving solution for the safe storage of needles, syringes and scalpels.

Catalog Number SS30

Packaged 10 per box, 4 boxes per case.



DriPAD™ Super Absorbent Pad

SUPER ABSORBENT TECHNOLOGY THAT HELPS YOU MANAGE THE RISK OF BIOHAZARDS

The DriPAD can be used underneath patients to protect linens and beds. It can also be conveniently placed on the floor to absorb spills, trapping fluids inside.

Super Absorbent Technology

- DriPADs absorb up to 35x their weight in fluids,* making them more efficient than the leading absorbent pad on the market. That's up to 10x more absorption power than alternative pads.
- A specially treated absorbent core draws fluid away from the surface and traps it in the interior, so that the surface remains dry.

Containment & Odor Control

- Each DriPAD features a robust polypropylene backing to provide a barrier that prevents leakage.
- An EPA registered Silver Ion agent helps control odors once fluids have been solidified deep inside the absorbable core. The Silver ion agent is present in both non-sterile and sterile pads.

ORDERING INFORMATION

Part Number	Description	Quantity
Sterile		
DRI0909E	9" x 9" Soaker Pad; absorbs and solidifies .47 liters (16oz.) of fluid	10 units
DRI2320E	23" x 20" Utility Pad; absorbs and solidifies 1.89 liters (64oz.) of fluid	5 units
DRI2332E	23" x 32" Large Pad; absorbs and solidifies 2.84 liters (96oz.) of fluid	5 units
DRI2360E	23" x 60" Stretcher-Size Gurney Pad; absorbs and solidifies 5.68 liters (192oz.) of fluid	5 units

Part Number	Description	Quantity
Non-sterile		
DRI0909	9" x 9" Soaker Pad; absorbs and solidifies .47 liters (16oz.) of fluid	10 units
DRI2320	23" x 20" Utility Pad; absorbs and solidifies 1.89 liters (64oz.) of fluid	5 units
DRI2332	23" x 32" Large Pad; absorbs and solidifies 2.84 liters (96oz.) of fluid	5 units
DRI2360	23" x 60" Stretcher-Size Gurney Pad; absorbs and solidifies 5.68 liters (192oz.) of fluid	5 units

Available in 4 sizes

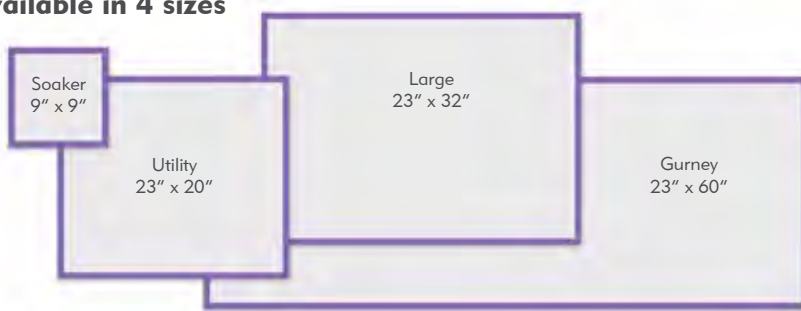

Absorption Capacities

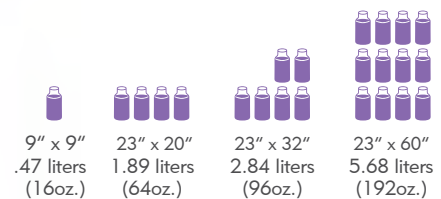

*Data on file

PAL™ - Pen & Labels

Strategically designed medication labeling system. The labels are made of moisture resistant polypropylene material. In addition, each PAL includes a sterile, smear resistant, permanent marker. Packaged 25 units per box, 4 boxes per case.

Catalog Number	Description
PAL100	Contains pen and label set of 35
PAL200	Contains pen and label set of 24
PAL225	Contains pen, label set of 24 and guide wire bowl label set of 5
PAL250	Contains pen, label set of 24 and large bowl label set of 7
PAL300	Contains pen and label set of 12
PAL325	Contains pen, label set of 12 and guide wire bowl label set of 5
PAL350	Contains pen, label set of 12 and large bowl label set of 7
PAL400	Contains pen and blank label set of 12
PAL425	Contains pen, blank label set of 12 and guide wire bowl label set of 5
PAL450	Contains pen, blank label set of 12 and large bowl label set of 7

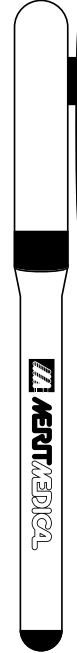

SAFETY & INFECTION CONTROL

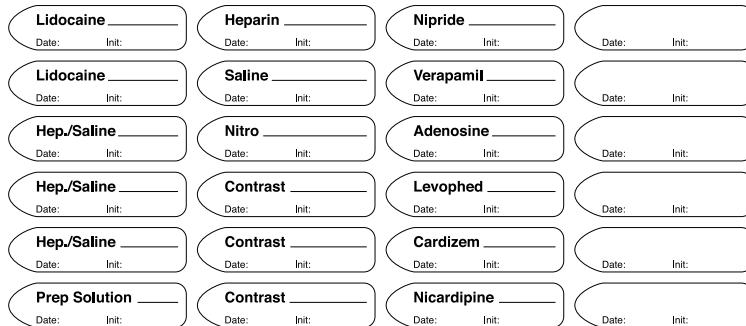
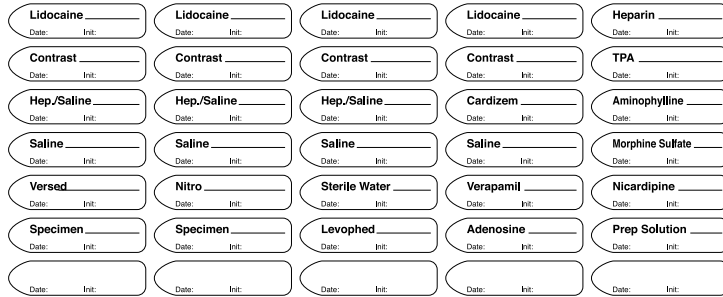

PAL 200 SERIES

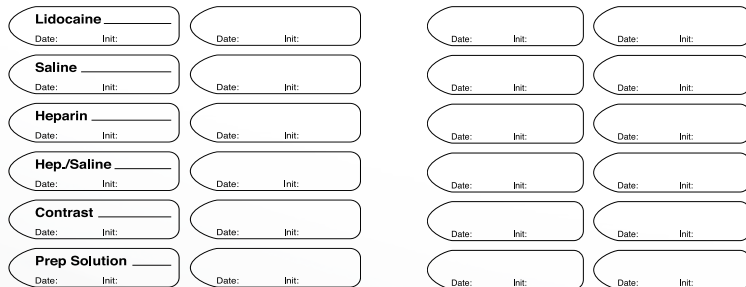

PAL 300 SERIES

PAL 400 SERIES

PAL™ - Pen & Labels

PAL500

Contains pen and guide wire bowl label set of 5

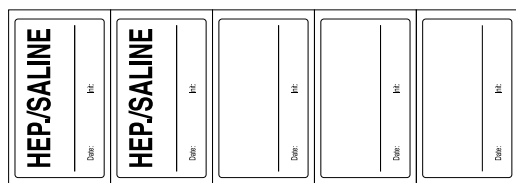

Catalog Number PAL500

PAL600

Contains pen and large bowl label set of 7

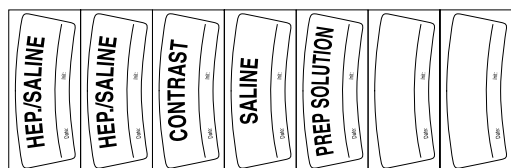

Catalog Number PAL600

PAL700

Contains pen, label set of 35 and large bowl label set of 7

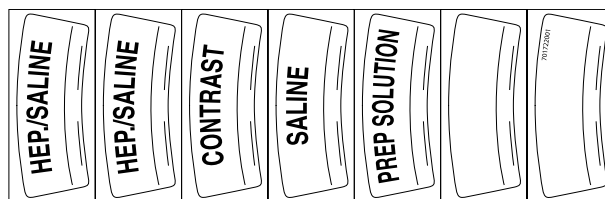
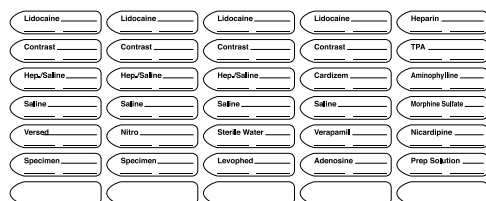

Catalog Number PAL700

All label pictures are not to scale.

PAL™ PEN

Sterile, smear resistant, permanent marker. Packaged 25 units per box, 4 boxes per case.



Catalog Number K13-00476

SAFETY & INFECTION CONTROL

Custom PAL™ Labels

Customers now have the option to have a custom label set created to meet their specific clinical needs.

Comply with the Joint Commission’s National Patient Safety Goals* using Merit Medical’s strategically designed custom medication labeling system.

Quickly and easily order all your custom medication labels with Merit’s revolutionary iPad app. Through the app, you’ll be able to select critical drug information, including drug name, dosing, date and signatures while maintaining complete compliance with the Joint Commission.

Contact your Merit Medical Sales Representative today for all your medication labeling needs.



STEP 1: CHOOSE A TEMPLATE

Label Set Template options for syringes, cups and small bowls:

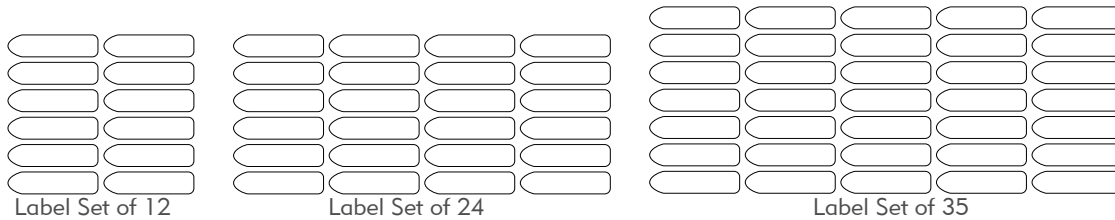

Label Set Template options for large bowls:

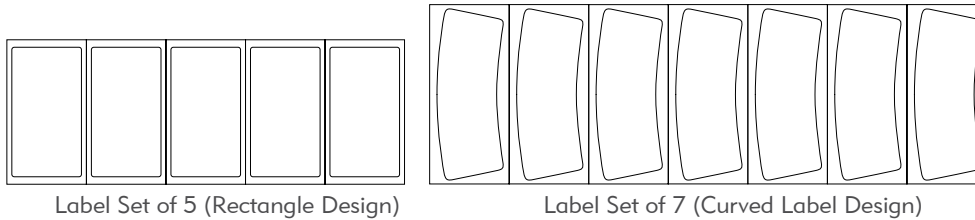

STEP 2: IDENTIFY THE MEDICATION NAMES YOU WOULD LIKE TO HAVE PRINTED ON EACH LABEL

STEP 3: CHOOSE THE APPROPRIATE COLORS FROM THE OPTIONS LISTED BELOW

Color Options:

- Red
- Dark Blue
- Blue
- Aqua
- Lt. Green
- Green
- Yellow
- Purple
- Pink
- Lt. Orange
- Orange
- White
- Transparent
- Gray
- Brown



Your Merit Representative will provide you with the corresponding Catalog number.

Most custom label sets are packaged 25 units per box, 4 boxes per case.

To better meet your clinical needs, each custom label set kit can contain a sterile permanent marker. The sterile permanent marker is also available stand alone.

NOTE: Custom label sets are available upon special request. Please allow up to six weeks for delivery.

* When label is completed at the time the medication or solution is prepared.



COMPLETE PROCEDURAL SOLUTIONS

78 Merit Value Packs™

84 Radial Drapes

85 Scatter Radiation Drapes

Angiography Tray 1

Includes

Quantity	Description
2	Band Bags 36" x 48" (91 x 122 cm)
1	Set Up Cover 44" x 77" (112 x 196 cm)
1	Dome Band Bag 22" Deep (56 cm)
1	Needle 18 G x 1.5" (40 mm)
1	Needle 21 G x 1.5" (40 mm)
1	Needle 22 G x 1.5" (40 mm)
1	Needle 25 G x 1.5" (40 mm)
1	#11 Futura® Safety Scalpel
1	Medicine Cup 2oz, 60 mL
1	Bowl 16oz, 500 mL
1	Bowl 32oz, 1000 mL
1	Guide Wire Bowl 2000 mL
1	Tray 9" x 5" x 2" (23 x 12 x 5 cm)
1	Curved Forceps 5" (13 cm)
50	4" x 4" (10 x 10 cm) Gauze Pads (12 Ply)
6	Cloth Towels (Blue)
4	Towel Clamps
3	Sponge Sticks 8" (20 cm)
2	XL NRF Gowns
1	Back Table Cover 50" x 90" (127 x 229 cm)
1	Femoral Drape 86" x 135" (206 x 343 cm) with 2 Windows
2	Line Identification Labels (Red/Yellow/Blue/White)
1	Merit Disposal Depot™ Waste Bag (MDD200HP)
1	Angiographic Needle 18 G x 2 3/4" (7 cm) Thin Wall
3	Medallion® Syringes 20 mL L/L, White, Saline
2	Medallion Syringes 10 mL L/L, Lt Blue, Lidocaine
2	Medallion Syringes 10 mL L/L, Yellow, Contrast
1	ShortStop® Temporary Sharps Holder
1	Manifold Setup With OFF Handles*

***MANIFOLD SETUP CONTAINS:**

- 203HN-R - 3-Port Manifold
- 1st Port - PM6172 - Pressure Monitoring Tubing
- 2nd Port - FAS5072 - Tubing w/ Large Bore Spike
- 3rd Port - FAS1272 - Tubing w/ Non-Vented Macro Drip Chamber, Male Luer
- CCX010 - Coronary Control Syringe
- M3SNC - 3-Way Stopcock

Packaged 4 per case.

Catalog Number K09T-11906

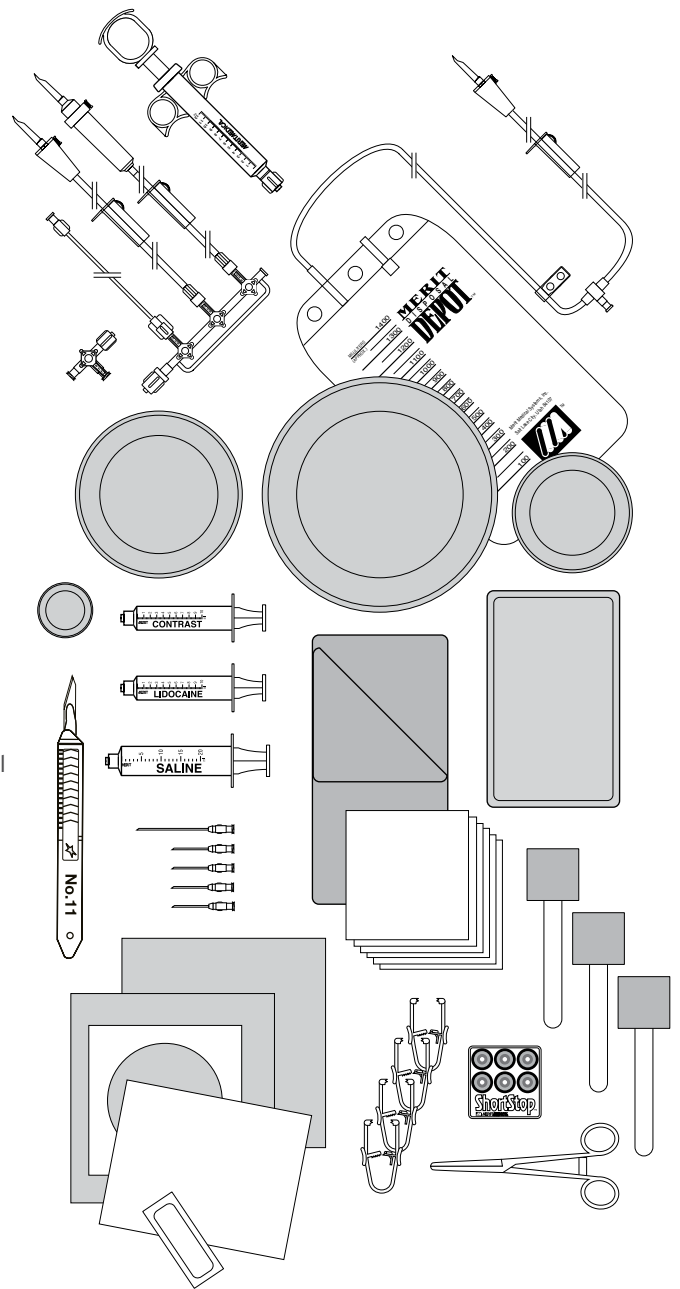

Angiography Tray 3

Includes

Quantity	Description
2	Band Bags 36" x 48" (91 x 122 cm)
1	Set Up Cover 44" x 77" (112 x 196 cm)
1	Dome Band Bag 22" Deep (56 cm)
1	Needle 18 G x 1.5" (40 mm)
1	Needle 21 G x 1.5" (40 mm)
1	Needle 22 G x 1.5" (40 mm)
1	Needle 25 G x 1.5" (40 mm)
1	#11 Futura® Safety Scalpel
1	Medicine Cup 2oz, 60 mL
1	Bowl 16oz, 500 mL
1	Bowl 32oz, 1000 mL
1	Guide Wire Bowl 2000 mL
1	Tray 9" x 5" x 2" (23 x 12 x 5 cm)
1	Curved Forceps 5" (13 cm)
50	4" x 4" (10 x 10 cm) Gauze Pads (12 Ply)
6	Cloth Towels (Blue)
4	Towel Clamps
3	Sponge Sticks 8" (20 cm)
2	XL NRF Gowns
1	Back Table Cover 50" x 90" (127 x 229 cm)
1	Femoral Drape 86" x 135" (206 x 343 cm) with 2 Windows
2	Line Identification Labels (Red/Yellow/Blue/White)
1	Merit Disposal Depot™ Waste Bag (MDD200HP)
1	Angiographic Needle 18 G x 2 3/4" (7 cm) Thin Wall
3	Medallion® Syringes 20 mL L/L, White, Saline
2	Medallion Syringes 10 mL L/L, Lt Blue, Lidocaine
2	Medallion Syringes 10 mL L/L, Yellow, Contrast
1	ShortStop® Temporary Sharps Holder
1	Manifold Setup With ON Handles*

***MANIFOLD SETUP CONTAINS:**

- 203HF-R - 3-Port Manifold
- 1st Port - PM6172 - Pressure Monitoring Tubing
- 2nd Port - FAS5072 - Tubing w/ Large Bore, Fixed Male Luer
- 3rd Port - FAS1272 - Tubing w/ Small Bore, Macro Drip Chamber
- CCX010P/B - Coronary Control Syringe
- M3SNP - 3-Way Stopcock

Packaged 4 per case.

Catalog Number K09T-11907

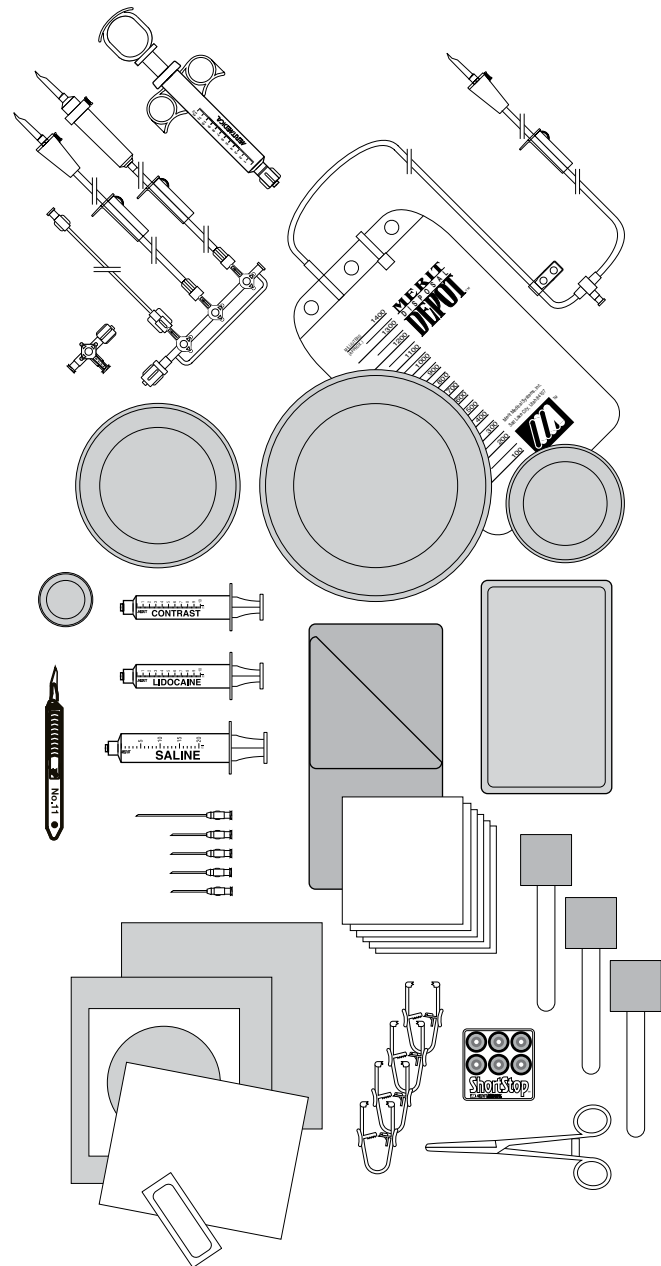

COMPLETE PROCEDURAL SOLUTIONS

Custom Angiography Kits

When your clinical needs are unique, Merit Medical can customize an angiography kit to meet your specific requirements. A Merit Sales Representative can assist you in combining Merit components into a single kit.

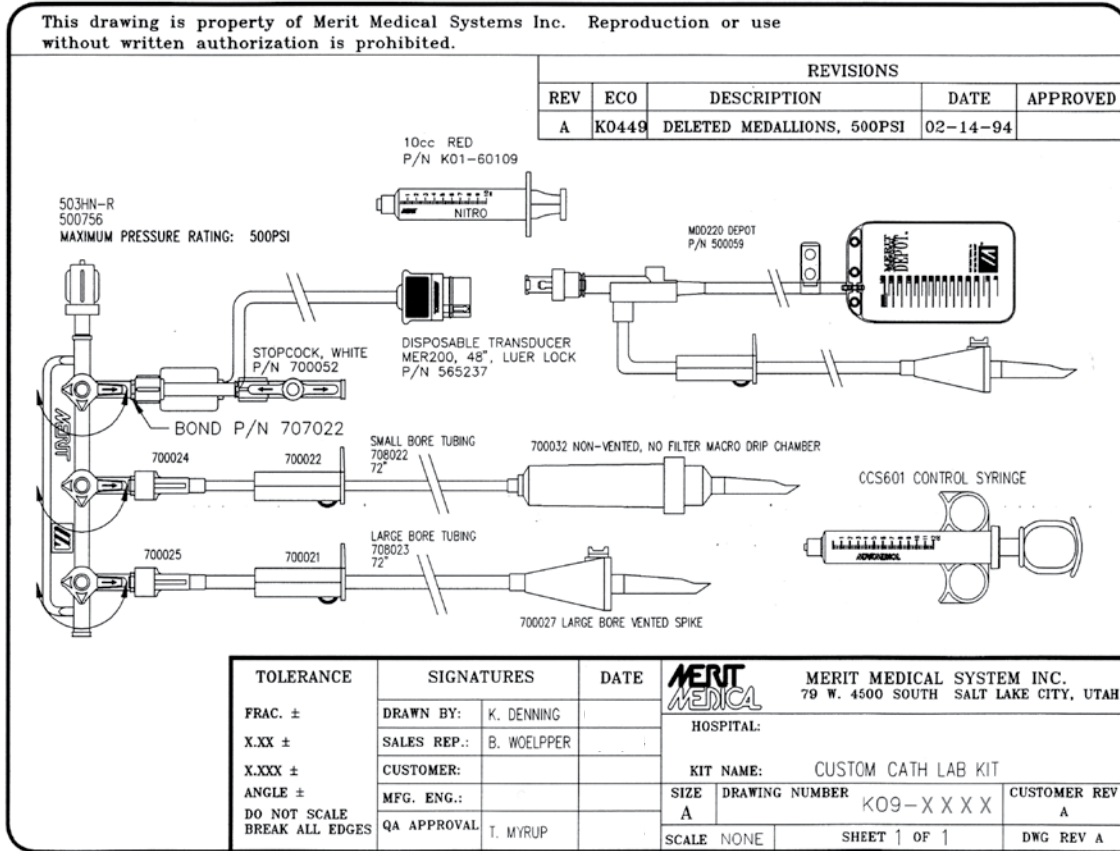

NOTE: All custom kits require a signed drawing (example above) and contract.

All components within the kit require market authorization in the country of sale.

Pericardiocentesis Kits

8.3F PERICARDIOCENTESIS PROCEDURE KIT

Designed to assist the clinician in draining fluid from the pericardial sac.

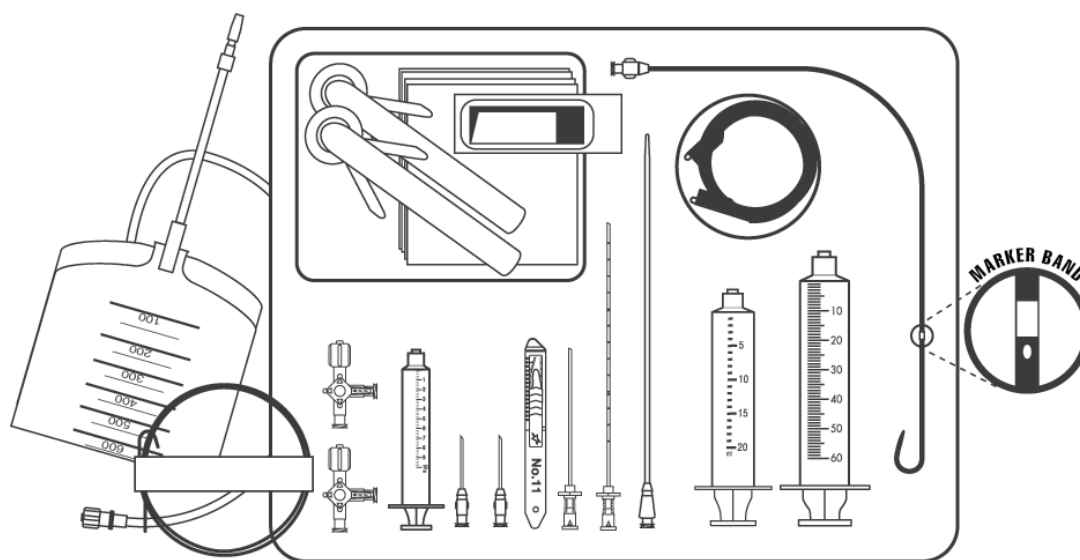

Includes

Quantity	Description
1	8.3F Pigtail or straight catheter, 40 cm with one marker band
1	8.5F Dilator 22 cm length
1	Guide wire: 0.035" (0.89 mm) x 80 cm, 3 mm J, double ended standard PTFE
2	3-way Stopcocks large bore
1	18G x 1 1/2" (3.8 cm) Medication Needle
1	25G x 1 1/2" (3.8 cm) Medication Needle
1	18G x 3" (9 cm) Access needle
1	18G x 5.9" (15 cm) Chiba Access needle
1	10 mL Luer lock syringe
1	20 mL Luer lock syringe
1	60 mL Luer lock syringe
1	1000 mL Merit Disposal Depot™ waste bag with drainage spout
10	4" x 4" (10 cm x 10 cm) Gauze sponges
1	61 cm x 61 cm Fenestrated drape
1	46 cm x 66 cm Absorbent barrier drape
1	Double-ended alligator clip cable
1	CSR Drape
1	#11 Futura® Safety Scalpel
1	3.0 silk suture with curved needle
1	Medication label set
2	3 mL ChloraPrep® (orange tint)

Catalog Number	Description
PC801	Pigtail Shape
PC802	Straight Shape
PC803EU	Pigtail Shape; kit does not include ChloraPrep®
PC804EU	Straight Shape; kit does not include ChloraPrep®

Pericardiocentesis Kits PC801 and PC802 do not have the CE Marking.
ChloraPrep® is a registered trademark of CareFusion 2200, Inc.

Pericardiocentesis Kits

6F PERICARDIOCENTESIS PROCEDURE KIT

Designed to assist the clinician in draining fluid from the pericardial sac.



Includes

Quantity	Description
1	6F High-flow pigtail or straight catheter 60 cm
1	6F Dilator 22 cm length
1	3-way stopcock
1	Guide wire 0.035" (0.89 mm) x 80 cm
	Double ended Heavy Duty PTFE (J & straight)
1	22G x 2 3/8" (6 cm) Medication Needle
1	19G x 1 1/2" (3.8 cm) Medication Needle
1	18G x 3" (9 cm) Access Needle
1	18G x 5.9" (15 cm) Chiba Access Needle
1	10 mL Luer lock syringe
1	60 mL Luer lock syringe
1	1400 Merit Disposal Depot™ waste bag with connecting tube
10	4" x 4" (10 cm x 10 cm) Gauze sponges
1	40 cm x 40 cm Fenestrated drape
1	46 cm x 66 cm Absorbent barrier drape
1	Double-ended alligator clip cable
1	CSR wrap
1	#11 Futura® Safety Scalpel

Packaged 4 kits per box.

Catalog Number	Description
PC101	6F High-flow pigtail catheter
PC201	6F High-flow straight catheter

Rapid Response Right Heart Kits

Right Heart Kits are pre-assembled and include necessary pressure monitoring and fluid management components.

RAPID RESPONSE RIGHT HEART ON KIT

2-port manifold, ON handle with transducer, 60" (152 cm) pressure monitoring tubing, and 60" (152 cm) non-vented small bore tubing flush line. Packaged 10 units per box, 4 boxes per case.

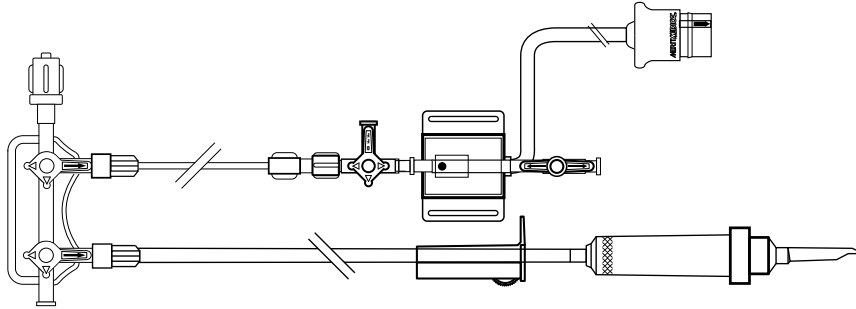

Catalog Number K09-10471

RAPID RESPONSE RIGHT HEART OFF KIT

2-port manifold, OFF handle with transducer, 60" (152 cm) pressure monitoring tubing, and 60" (152 cm) non-vented small bore tubing flush line. Packaged 10 units per box, 4 boxes per case.

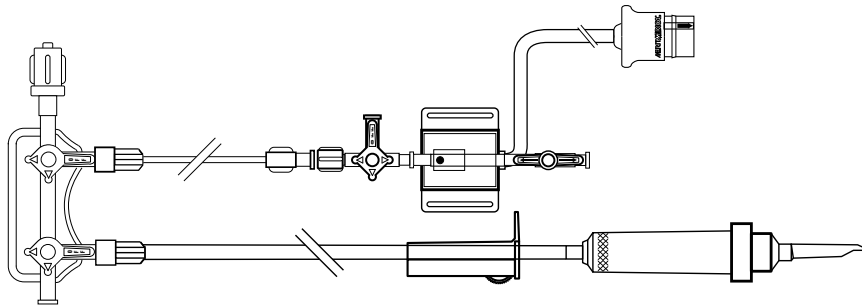

Catalog Number K09-10472

All components within the kit require market authorization in the country of sale.

Radial Drapes

The 4-Hole Drapes are standalone convenience products for radial procedures that Merit Medical has made available for clinical settings where a fenestrated drape outside of the procedure pack is necessary or desired. Packaged 10 per case.

Catalog Number	Description
K12T-04696	Femoral Radial Angiography Drape, Angled 4-hole
K12T-05047	Standard 4-hole drape
K12T-09342	First Radial Drape Pack

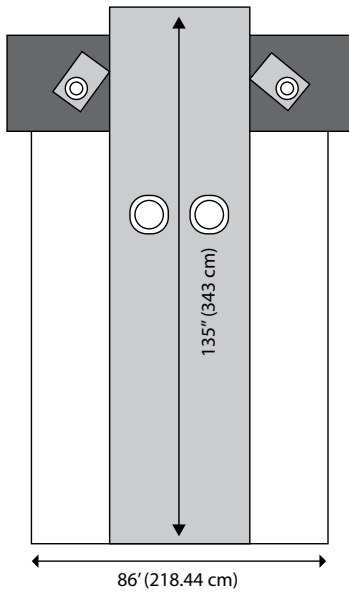

K12T-04696

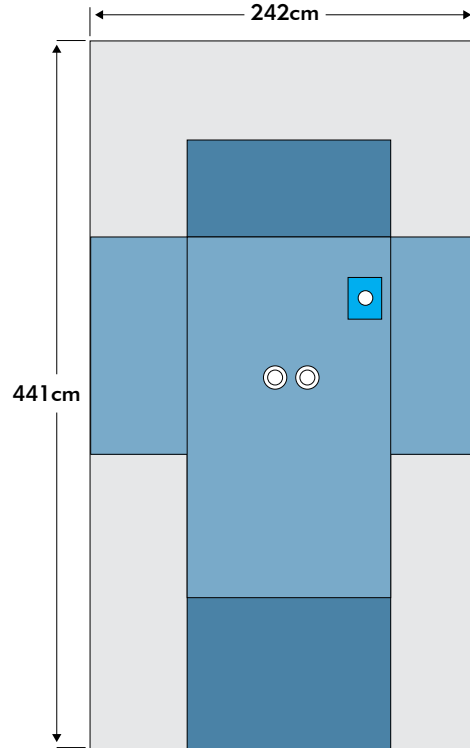

K12T-09342

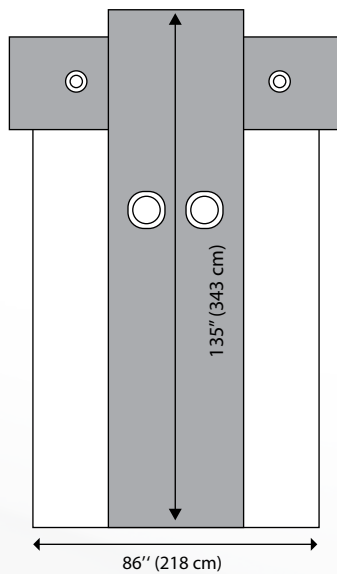

K12T-05047

Drape Armour® - Scatter Radiation Drapes

These positional protection shields are designed to protect at the procedure site where scatter radiation is most prevalent. They can help protect surgeons and other members of the clinical staff, and offer substantial attenuation as demonstrated by direct beam studies. Packaged 10 per case.

Catalog Number	Description
K12T-07302	16 x 10 Radiation Pad
K12T-07303	16 x 14 Radiation Pad
K12T-07304	16 x 16 Radiation Pad
K12T-07362	16 x 10 Radiation Pad LOW
K12T-07363	16 x 14 Radiation Pad LOW
K12T-07364	16 x 16 Radiation Pad LOW
K12T-07361	16 x 13 x 9 "L" Radiation Pad

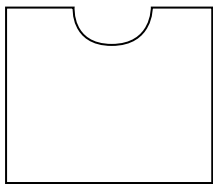
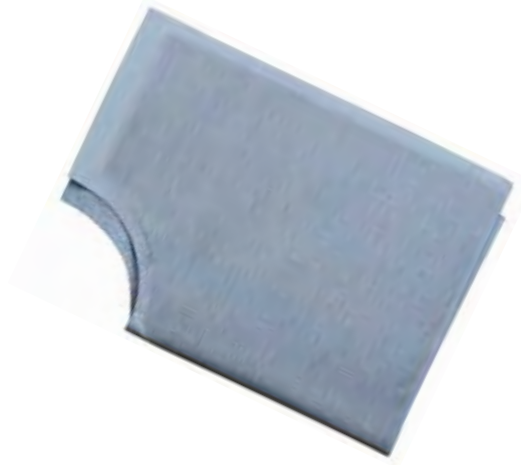

K12T-07302

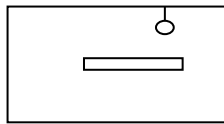

K12T-07303

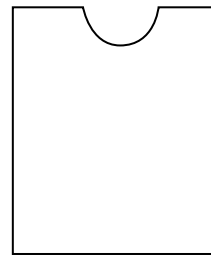

K12T-07304

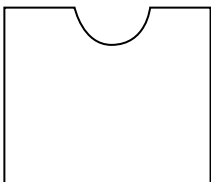

K12T-07362

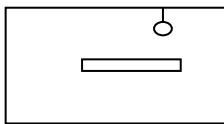

K12T-07363

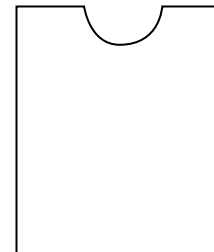

K12T-07364

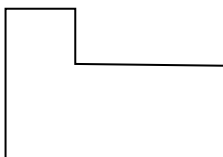

K12T-07361

COMPLETE PROCEDURAL SOLUTIONS



ACCESSORIES

87 Pressure Infusor Bags™

88 Flow Control Switch

PIB - Pressure Infusor Bags™

Nylon bags for pressurization of fluids. Dual-setting pressure relief valve easily switches between standard and overpressure mode with the click of a button (PIB500 and PIB1000 only).

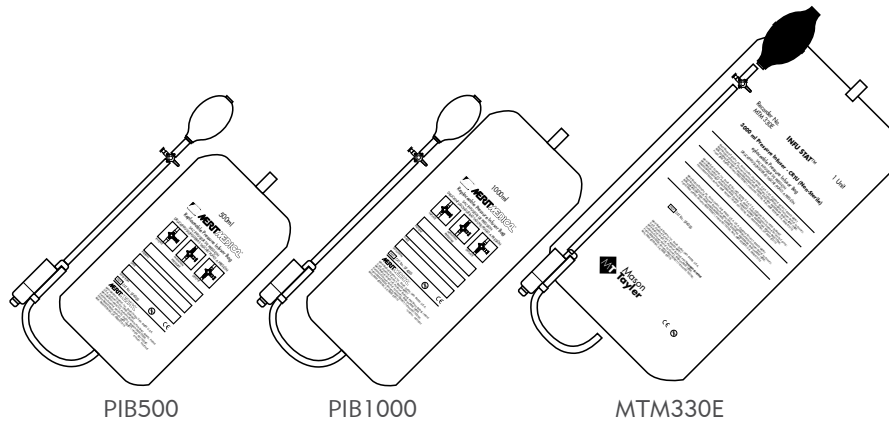

Catalog Numbers	Description
PIB500	500 mL 12 per box, 48 per case
PIB1000	1000 mL 12 per box, 48 per case
MTM330E	3000 mL 2 per box, 10 per case



ACCESSORIES

Flow Control Switch

The Merit Medical Flow Control Switch gives you the confidence you need when stopping and starting flow during critical procedures. This feature-rich, integrated, one-handed, single channel device is designed with clinician and patient safety in mind. Merit's High Pressure Flow Control Switch can be used with any application that involves liquid flow and requires inline shut off capability.

- Audible switch ensures ease of use and confirmation of open/close
- High pressure capable of pressures up to 1200 psi in dynamic (ON) applications
- On/Off slider switch one-handed actuation
- Customization options available

CATALOG

NUMBER	DESCRIPTION	SLIDER COLOR	BOX QUANTITY
U1SHC	Flow Control Switch	Blue	24
U1SHC-W	Flow Control Switch	White	24
U1SHC-R	Flow Control Switch	Red	24
U1SHC-Y	Flow Control Switch	Yellow	24
U1SHC-G	Flow Control Switch	Green	24

Pressure Rating: Open 1200 psi, Closed 150 psi

Lumen I.D.: 0.065 inches

Connectors: Male to Female

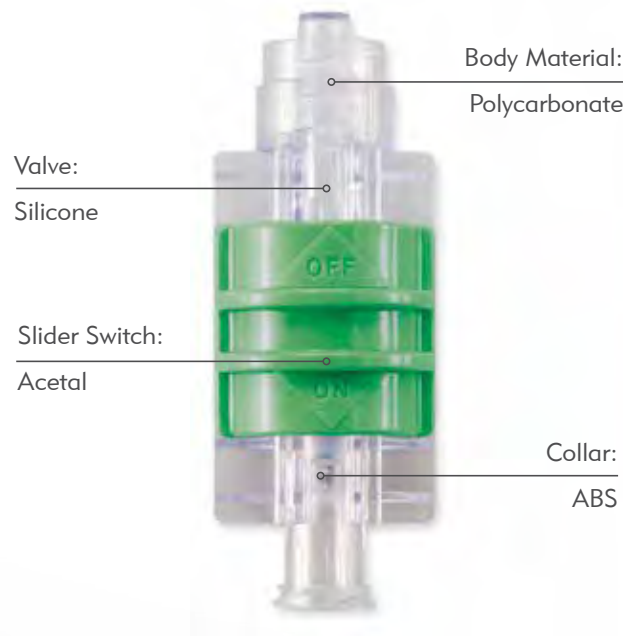

UNDERSTAND. INNOVATE. DELIVER.™

Merit Medical Systems is a worldwide leader in the development, manufacturing, and distribution of quality medical devices used in interventional and diagnostic procedures. With a global workforce and cutting-edge manufacturing facilities equipped with the most advanced technology, Merit Medical consistently delivers quality products that are backed by excellent service and professional expertise.

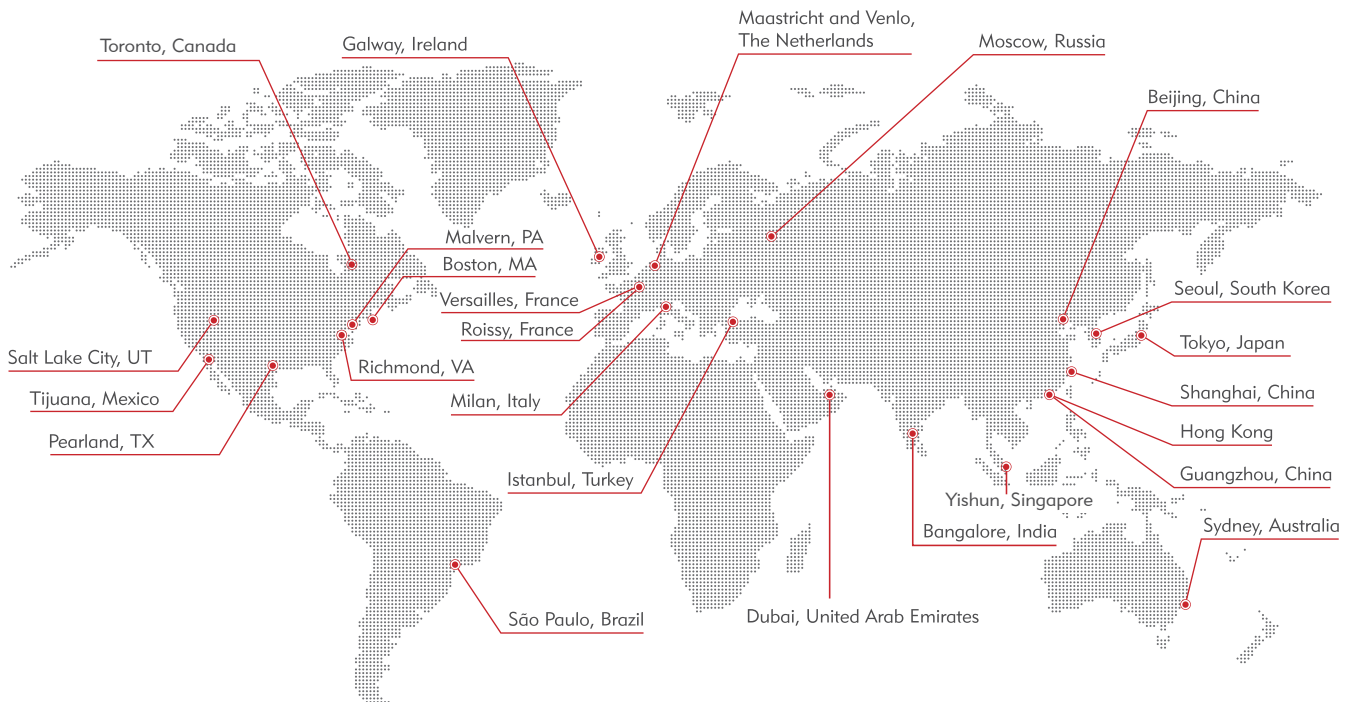

Understand. Innovate. Deliver.™

Merit Medical Systems, Inc.
 1600 West Merit Parkway
 South Jordan, Utah 84095
 1.801.208.4300
 1.800.35.MERIT

Merit Medical Europe, Middle East, & Africa (EMEA)
 Amerikalaan 42, 6199 AE Maastricht-Airport
 The Netherlands
 +31 43 358 82 22

Merit Medical Ireland Ltd.
 Parkmore Business Park West
 Galway, Ireland
 +353 (0) 91 703 733

Merit.com

Australia
 +61 (0) 3 8373 4943

Austria
 0800 295 374

Belgium
 0800 72 906 (Dutch)
 0800 73 172 (Français)

Brazil
 +55 11 4561 - 0062

Canada
 1.800.364.4370

China
 +86-10 8561 0788

Denmark
 80 88 00 24

Finland
 0800 770 586

France
 0800 91 60 30

Germany
 0800 182 0871

Hong Kong
 +852-2207 6888

India
 +91-80-41223376

Ireland (Republic)
 1800 553 163

Italy
 800 897 005

Korea
 +8210 2205 0707

Luxembourg
 8002 25 22

Netherlands
 0800 022 81 84

Norway
 800 11629

Portugal
 308 801 034

Russia
 +7 495 221 89 02

Spain
 +34 911238406

Sweden
 020 792 445

Switzerland
 (Deutsch)
 +41 22 518 02 30

(Français)
 +41 22 518 02 52

(Italiano)
 +41 22 518 00 35

UK
 0800 973 115